



**PROMODAY**  
**2021**

ITALIA € IVA ESCLUSA



	<b>CHIAVI DI MANOVRA</b>	<b>2</b>
	<b>CHIAVI A BUSSOLA</b>	<b>6</b>
	<b>GIRAVITI E PINZE</b>	<b>16</b>
	<b>ELETTROTECNICA/ELETTRICITA'</b>	<b>20</b>
	<b>UTENSILI DINAMOMETRICI</b>	<b>22</b>
	<b>MANUTENZIONE GENERALE</b>	<b>24</b>
	<b>VALIGIE PORTA-UTENSILI</b>	<b>30</b>
	<b>ESTRATTORI</b>	<b>32</b>
	<b>UTENSILI PNEUMATICI</b>	<b>34</b>
	<b>AUTOMOTIVE</b>	<b>42</b>
	<b>CARRELLI E BANCHI DA LAVORO</b>	<b>58</b>
	<b>ARREDAMENTO TECNICO</b>	<b>88</b>
	<b>EQUIPMENT</b>	<b>94</b>



# CHIAVI DI MANOVRA

## LA CLASSICA

ANELLO POSTERIORE  
INCLINATO A 15°

FINITURA  
SATINATA LUCIDA

CORPO CENTRALE INCAVO  
PER UNA MAGGIORE PRESA

BOCCA ANTERIORE  
RINFORZATA



### FG 600/SC17

SET 17 CHIAVI COMBinate  
POLIGONALI IN BOX DI CARTONE

CONTENUTO:  
6, 7, 8, 9, 10, 11, 12, 13, 14,  
15, 16, 17, 18, 19, 20, 21, 22 mm



~~156,50€~~ 92,50€

### FG 600/SC16

SET 16 CHIAVI  
COMBinate POLIGONALI

CONTENUTO:  
6,7,8,10,12,13,14,16,  
17,19,21,22,24,27,30,32 mm



~~197,80€~~ 109,00€

### FG 600/ST9

SET 9 CHIAVI COMBinate  
POLIGONALI CON  
SUPPORTO IN ABS

CONTENUTO:  
8,10,11,12,13,14,15,17,19 mm



~~83,10€~~ 49,90€

### FG 600/SC25

SET 25 CHIAVI COMBinate  
POLIGONALI IN BOX DI CARTONE

CONTENUTO:  
6, 7, 8, 9, 10, 11, 12, 13, 14, 15, 16,  
17,18, 19, 20, 21, 22, 23, 24, 25, 26, 27,  
28, 30,32 mm



~~315,80€~~ 169,00€

## EXTRA-PIATTA

### FG 602C/SP9

SET CHIAVI A DOPPIA FORCHETTA  
ULTRA PIATTE IN ROTOLO DI NYLON

CONTENUTO:  
6x7,8x9,x10x11,x12x13,14x15,  
16x17,18x19, 20x22,21x23

~~74,00€~~ 39,90€



### FG 602/ST7

SET CHIAVI A DOPPIA FORCHETTA  
CON SUPPORTO IN ABS

CONTENUTO:  
6x7, 8x9, 10x11, 12x13,  
14x15, 16x17, 18x19mm

~~39,00€~~ 22,90€





**FG 609A/S5**

**SET 5 CHIAVI  
DOPPIE POLIGONALI**

**CONTENUTO:**  
10x12, 11x13,  
14x17, 16x18, 19x22

~~77,50€~~

**46,50€**

**FG 613/S9**

**SET CHIAVI A PIPA  
ESAGONALI-POLIGONALI  
IN BOX DI CARTONE**

**CONTENUTO:**  
8, 10, 11, 12, 13, 15, 17,  
18, 19 mm

~~135,00€~~

**79,00€**



**FG 619H/S5**

**SET CHIAVI A T MASCHIO ESAGONALI  
SNODATE IN BOX DI CARTONE**

**CONTENUTO:**  
3, 4, 5, 6, 8, mm

~~138,00€~~

**82,90€**

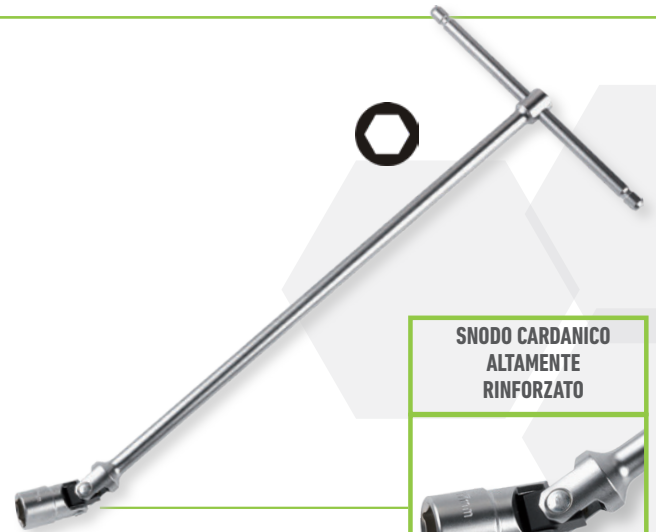

**SNODO CARDANICO  
ALTAMENTE  
RINFORZATO**



**FG 618/S7B**

**SET 7 CHIAVI A T  
SNODATE ESAGONALI**

**CONTENUTO:**  
7, 8, 10, 12, 13, 14, 17mm

~~195,00€~~

**119,00€**



**FG 619TX/S8**

**SET CHIAVI A T SNODATE  
TORX IN BOX DI CARTONE**

**CONTENUTO:**  
TX20, 25, 27, 30, 40, 45, 50, 55

~~265,00€~~

**156,00€**



**FG 618/S7**

**SET 7 CHIAVI A T  
SNODATE ESAGONALI**

**CONTENUTO:**  
8, 10, 11, 13, 14, 17, 19 mm

~~220,00€~~

**129,00€**



**FG 618/S10**

**SET 10 CHIAVI A T  
SNODATE ESAGONALI**

**CONTENUTO:**  
8, 10, 11, 12, 13, 14,  
15, 16, 17, 19 mm

~~330,00€~~

**199,00€**

# CHIAVI DI MANOVRA

ASTA SCORREVOLE

ASTA SCORREVOLE



**FG 621H/S8C**

CHIAVI A T MASCHIO ESAGONALI  
CON ASTA SCORREVOLE

CONTENUTO: 2,2,5,3,4,5,6,8,10mm

~~126,00€~~ **75,00€**



**FG 621TX/S13**

CHIAVI A T MASCHIO TORX

CONTENUTO: 6,7,8,9,10,15, 20,25,27,  
30,40, 45,50 TX

~~199,80€~~ **119,00€**

ASTA FISSA

## SERIE INDUSTRIA



**FG 622H/S6**

SET CHIAVI A T MASCHIO ESAGONALE

CONTENUTO: 2,5, 3, 4, 5, 6, 8mm

~~132,00€~~ **79,90€**

**FG 622H/S7**

SET CHIAVI A T MASCHIO ESAGONALE

CONTENUTO: 2,5, 3, 4, 5, 6, 8, 10mm

~~170,00€~~ **104,00€**

CHIAVE COMBINATA A CRICCO  
REVERSIBILE CON ANELLO DI TENUTA

ANELLO IN ACCIAIO INTEGRATO CHE  
CONSENTE LA TENUTA DEL BULLONE

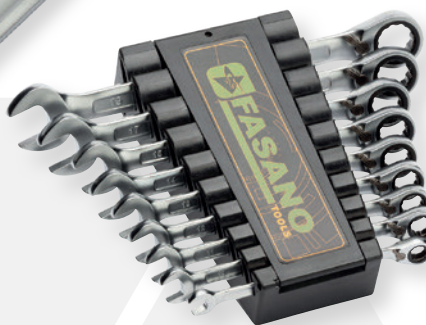

**FG 605/ST9-B**

SET CHIAVI A CRICCO REVERSIBILI  
CON SUPPORTO IN ABS

CONTENUTO: 8,10,11,12,13,14,15,17,19mm

~~145,00€~~ **89,00€**

**FG 605/ST11-B**

SET CHIAVI A CRICCO REVERSIBILI  
CON SUPPORTO IN ABS

CONTENUTO: 8,9,10,11,12,13,14,15,16,17,19mm

~~180,00€~~ **109,00€**

LEVA DI INVERSIONE A FILO TESTA E CON  
LINGUETTA INCLINATA VERSO IL BASSO PER  
UN MAGGIORE SPAZIO DI MANOVRA

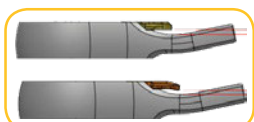



**FG 606/SP9**

**SET 9 CHIAVI COMBinate A CRICCO NON REVERSIBILE IN ROTOLO DI NYLON**

CONTENUTO: 8,10,11,12,13,14,15,17,19 mm

~~105,00€~~ **62,50€**



**FG 610FL/SP9**

**SET 9 CHIAVI COMBinate A CRICCO FLESSIBILI IN ROTOLO DI NYLON**

CONTENUTO: 8, 10, 12, 13, 15, 16, 17, 18, 19 mm

~~186,00€~~ **112,50€**



**FG 615A/S6**

**SET 6 CHIAVI DOPPIE CON CRICCO REVERSIBILE UNIVERSALE A 90 DENTI**

CONTENUTO: 8x9, 10x11, 12x13, 14x15, 16x18, 17x19mm

~~118,00€~~ **69,00€**



**FG 617B/S5**

**SET 5 CHIAVI A DOPPIO CRICCO FLESSIBILE UNIVERSALE**

CONTENUTO: 8x10, 12x14, 13x15, 16x18, 17x19mm

~~108,00€~~ **64,90€**



**FG 620A/S5**

**SET 5 CHIAVI A TESTA FLESSIBILE E CRICCO UNIVERSALE**

CONTENUTO: 8, 10, 13, 14, 17mm

~~75,00€~~ **45,00€**



**FG 622A/S6**

**SET 6 CHIAVI A CRICCO UNIVERSALE SERIE EXTRA-LUNGA**

CONTENUTO: 8x9, 10x11, 12x13, 14x15, 16x18, 17x19 mm

~~120,00€~~ **72,00€**



**FG 622A/S2**

**SET 2 CHIAVI A CRICCO UNIVERSALE SERIE EXTRA-LUNGA**

CONTENUTO: 21x22, 24x27 mm

~~75,00€~~ **45,00€**

# CHIAVI A BUSSOLA

1/4"

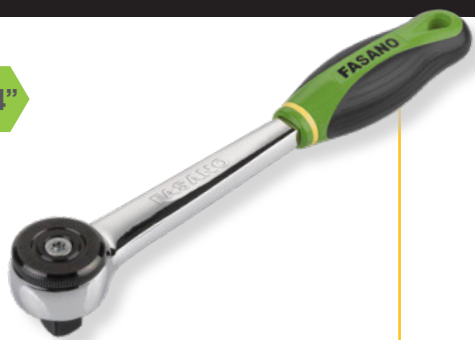

**FG 624/CR14**

**CRICCHETTO REVERSIBILE DA 1/4"**

- Sistema di inversione a ghiera integrato sulla testa
- Meccanismo a 72 denti
- Cromatura lucida
- Asola di aggancio

~~32,50€~~

**19,90€**



**FG 624/FR14**

**CRICCHETTO REVERSIBILE DA 1/4"**

- Modello con testa chiusa anti polvere
- Leva di inversione integrata a filo testa
- Corpo scavato di 13° per consentire l'utilizzo anche in spazi particolarmente difficoltosi
- Meccanismo a 72 denti
- Cromatura lucida e asola di aggancio

~~35,00€~~

**21,50€**



**FG 624/RT14**

**CRICCHETTO REVERSIBILE DA 1/4"**

- Sistema di avanzamento rotativo integrato nell'impugnatura
- Meccanismo a 60 denti
- Cromatura lucida e asola di aggancio

~~50,00€~~

**29,90€**

**FG 624/MCR**

**MINI-CRICCHETTO CON ATTACCO QUADRO 1/4" A 72 DENTI**



~~30,00€~~

**17,90€**

**FG 624/MCH**

**MINI-CRICCHETTO CON ATTACCO ESAGONALE PER INSERTI 1/4"**



~~30,00€~~

**17,90€**

**FG 624/S12**

**SET 11 CHIAVI A BUSSOLA ESAGONALI E CRICCHETTO SU SUPPORTO IN PLASTICA**

CONTENUTO: 4, 5, 6, 7, 8, 9, 10, 11, 12, 13, 14 mm FG 624/CR14



~~74,00€~~

**45,00€**

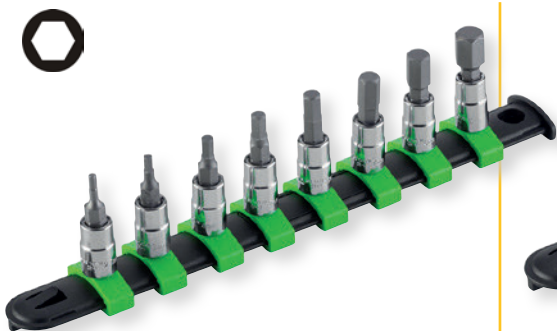

**FG 147H/S8**

**SET 8 INSERTI A BUSSOLA 1/4" PER VITI CON IMPRONTA ESAGONALE**

CONTENUTO: 2,5, 3,4,5,6,7,8,10

~~52,00€~~

**29,90€**



**FG 147PT/S6**

**SET 6 INSERTI A BUSSOLA PENTALOMBATI DA 1/4"**

CONTENUTO: PT10, 15, 20, 25, 27, 30

~~58,00€~~

**34,90€**

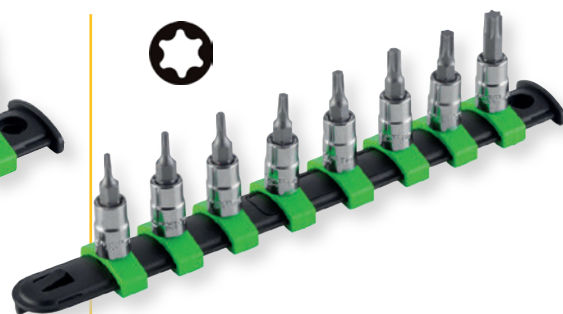

**FG 147TX/S8**

**SET 8 INSERTI A BUSSOLA DA 1/4" TORX**

CONTENUTO: TX9-TX40

~~65,00€~~

**37,90€**

~~72,00€~~ 39,90€



**FG 624/S25**

SET 25 UTENSILI CON ATTACCO QUADRO 1/4"



FG 624/E: 6, 8,10,11,12,13mm



FG 624/CR14



FG 89/38PI1 (1/4x1/4)



FG 85/25PH1, PH2, PH3



FG 85/25PZ1, PZ2, PZ3



FG 85/25F4, F5, F6, F7



FG 85/25TX10, TX15, TX20, TX25, TX30, TX40

~~110,00€~~ 59,90€



**FG 624/S18**

SET 18 UTENSILI CON ATTACCO QUADRO 1/4"



FG 624/E4,5,6,7,8,9,10,11,12,13,14mm



FG 624/CR14



FG 624/ES14

FG 624/PA50, 100

FG 624/PRF150



FG 624/GR14C



FG 624/SN14

~~170,00€~~ 99,00€



**FG 624/S45**

SET 45 UTENSILI DA 1/4"



FG 624/E4,5,6,7,8,9,10,11,12,13,14mm



FG 624/CR14



FG 624/PA50, 100

FG 624/PRF150



FG 624/ES14

FG 624/SN14



FG 624/GR14C



FG 148/H1.5-H10 / FG 148/TX8-TX40

FG 148/PH1-PH4 / FG 148/F1-F5



# CHIAVI A BUSSOLA

3/8"

~~220,00€~~

135,00€



FG 624B/S80

SET 80 UTENSILI DA 3/8"



FG 624/B8,9,10,11,12,13,14,  
15,16,17,18,19,21,22,23

FG 624B/L8,10,13,17,19



FG 624/CR38



FG 624/SN38



FG 149/H3,4,5,6,7,8, 10

FG 149/TX9,10,15,20,25,27,30,40



FG 624/ES38



FG 624B/PA75,125,150,250



FG 600/B8,10,13,15,17,19



FG 89/50PI2 3/8"x1/4"

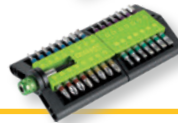

FG 85/S31

FG 624B/S16

~~140,00€~~

79,90€

SET 15 CHIAVI A BUSSOLA  
ESAGONALI 3/8" E CRICCHETTO

CONTENUTO: 8, 9, 10, 11, 12, 13,  
14, 15, 16, 17, 18, 19, 21, 22, 23mm  
FG 624/CR38



FG 624/CR38

CRICCHETTO  
REVERSIBILE DA 3/8" -  
MECCANISMO 72 DENTI



~~35,00€~~

19,90€

FG 624B/TXS10

SET 10 CHIAVI A BUSSOLA  
EXTRA-LUNGHE CON  
IMPRONTA TORX

CONTENUTO: E6, E7, E8, E10,  
E11, E12, E14, E16, E18, E20



~~125,00€~~

69,90€

3/8"

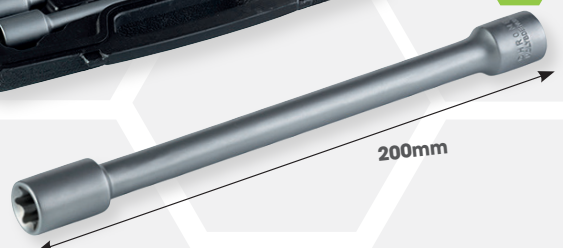

200mm

1/2"



~~130,00€~~

79,90€

FG 625/S27

SET 27 UTENSILI DA 1/2"



FG 625/A8,9,10,11,12,13,14,15,16,17,  
18,19,20,21,22,23,24,25,26,27,30,32



FG 625/CR12



FG 625/SN12



FG 625/ES12



FG 625/PA125, 250



1/4"

1/2"



~~265,00€~~

159,00€

FG 625/S109

SET 109 UTENSILI DA 1/4" 1/2"



FG625/A8,9,10,11,12,13,14,15,16,17,  
18,19,20,21,22,23,24,25,26,27,30,32



FG 624/E4,5,6,7,8,9,10,11,12,13,14



FG 624E/L4,5,6,7,8,9,10,11,12,13,14



FG 147/H2.5,3,4,5,6,7,8,10  
FG 147/TX9,10,15,20,25,27,30,40



FG 624/CR14  
FG 625/CR12



FG 625/SN12  
FG 624/SN14



FG 625/ES12  
FG 624/ES14



FG 624/GR14C



FG 625/PA125, 250  
FG 624/PA50



FG 89/38PI1 1/4"x1/4"



FG 92/PM1



FG 600/B8,10,13,15,17,19

FG 85/25PH1, PH2, PH3, PZ1, PZ2, PZ3  
FG 85/25SL3, SL4, SL4.5, SL5, SL5.5, SL6, L6.5  
85/H1.5, H2, 2.5, H3, H4, H5, H6  
FG 85/25TX9 - TX40, FG 88/60PI2



# CHIAVI A BUSSOLA

1/4"

1/2"

**FG BEST 108**

SET 108 UTENSILI DA 1/4" 1/2"

~~250,00€~~

**119,00€**



## FG BEST 108



FG 625/A10,11,12,13,14,15,16,  
17,18,19,20,21,22,23,24,27,30,32



FG 624/E4,4.5,5,5.5,6,7,8,9,10,11,12,13,14



FG 625L/A14,15,17,19,22



FG 624E/L6,7,8,9,10,11,12,13



FG 625/TX10,11,12,14,16,18,20,24



FG 624/TX4,5,6,7,8



FG 87/AD

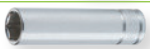

FG 181/B16,21 x CANDELE ACCENSIONE



FG 624/CR14  
FG 625/CR12



FG 625/SN12  
FG 624/SN14



FG 625/ES12  
FG 624/ES14



FG 624/GR14



FG 625/PR125  
FG 624/PR50,100



FG 139/D1.5,2,2.5



FG 147/PH1,PH2  
FG 147/PZ1,PZ2  
FG 147/SL4,SL5,5.SL6.5  
FG 147/H3,H4,H5,H6  
FG 147/TX10,TX15,TX20,TX25,TX30



FG 85/PH3,PH4  
FG 85/PZ3,PZ4  
FG 85/SL8,SL10,SL12  
FG 85/H7,H8,H10,H12,H14  
FG 85/TX40,TX45,TX50,TX55,TX60



1/4"

3/8"

1/2"



**FG BEST 171**

SET 171 UTENSILI DA 1/4", 3/8" E 1/2"

~~350,00€~~

**159,00€**

## FG BEST 171



FG 625/A10,11,12,13,14,15,16,  
17,18,19,20,21,22,23,24,27,30,32



FG 624/B10,11,12,13,14,15,16,17,18,19



FG 624/E4,4,5,5,5,6,7,8,9,10,11,12,13,14



FG 625L/A16,17,18,19,22  
FG 624B/L10,11,12,13,14,15  
FG 624/4,5,6,7,8,9,10



FG 625/TX20,24  
FG 624B/TX10,11,12,14,16,18  
FG 624/TX4,5,6,7,8



FG 181/B16,21 x CANDELE ACCENSIONE



FG 87/AD



FG 181/B16,21 x CANDELE ACCENSIONE



FG 624/CR14  
FG 624/CR38  
FG 625/CR12



FG 625/SN12  
FG 624/CR38  
FG 624/SN14



FG 625/ES12  
FG 624/ES14



FG 624/GR14



FG 625/PR125  
FG 624B/PR125  
FG 624/PR50,PR100



FG 139/D1,1.5,2,2.5,3,4,4.5,5



FG 147/PH0,PH1,PH2  
FG 147/PZ0,PZ1,PZ2  
FG 147/SL4,5,5,6,5,7  
FG 147/H3,H4,H5  
FG 147/TX8-TX30  
FG 147/RTX8-RTX30



FG 85/PH3,PH4  
FG 85/PZ3,PZ4  
FG 85/SL8,SL10,SL12  
FG 85/H7,H8,H10,H12,H14  
FG 85/TX40-TX50  
FG 85/TT10-TT45  
FG 85/M5-M9





# CHIAVI A BUSSOLA

1/4"

1/2"



FG 625/S110

SET 110 UTENSILI DA 1/4" 1/2"

~~398,80€~~

239,00€



FG 625/A8,9,10,11,12,13,14,15,16,17,  
18,19,20,21,22,23,24,25,26,27,30,32



FG 624/E4,5,6,7,8,9,10,11,12,13,14



FG 624/CR14  
FG 625/CR12



FG 625/SN12  
FG 624/SN14



FG 625/ES12  
FG 624/ES14



FG 624/GR14C



FG 625/PA125, 250  
FG 624/PA50, 100



FG 89/38PI1 1/4" x 1/4"



FG 85/25PH1, PH2, PH3  
FG 85/25SL3, SL4, SL4.5, SL5, SL5.5, SL6, L6.5  
FG 85/25PZ1, PZ2, PZ3  
FG 85/H1.5, H2, 2.5, H3, H4, H5, H6  
FG 85/25T9, T10, T15, T20, T25, T27, T30, T40  
FG 88/60PI2



FG 139/B



FG 48/L



FG 49



FG 600/B8,10,11,12,13,14,15,17,19

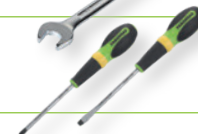

FG 22/3x75, 4x100, 5.5x100  
FG 22/PH0x60, PH1x80, PH2x100



FG 59SR/160  
FG 63SR/160



FG 58/B240



FG 132/H500



FG 79/SP

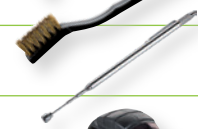

FG 92/PM1



FG 44/MT5

## FG 625TX/S9



### SET 9 CHIAVI A BUSSOLA DA 1/2" TORX

CONTENUTO: E8, E10, E12, E14, E16, E18, E20, E22, E24



~~68,00€~~ 39,90€

## FG 625LTX/S9



### SET 9 CHIAVI A BUSSOLA 1/2" TORX

CONTENUTO: 8, 10, 12, 14, 16, 18, 20, 22, 24 E



~~115,00€~~ 69,90€

## FG 625TX/S13

### SET 13 CHIAVI A BUSSOLA SNODATE CON IMPRONTA TORX

1/4": E4, E5, E6, E7, E8  
3/8": E10, E12, E14, E16  
1/2": E18, E20, E22, E24



~~150,00€~~ 89,90€

## FG 150TX/S11

### SET 11 INSERTI A BUSSOLA TORX 1/2"

CONTENUTO: TX10, TX15, TX20, TX25, TX27, TX30, TX40, TX45, TX50, TX55, TX60

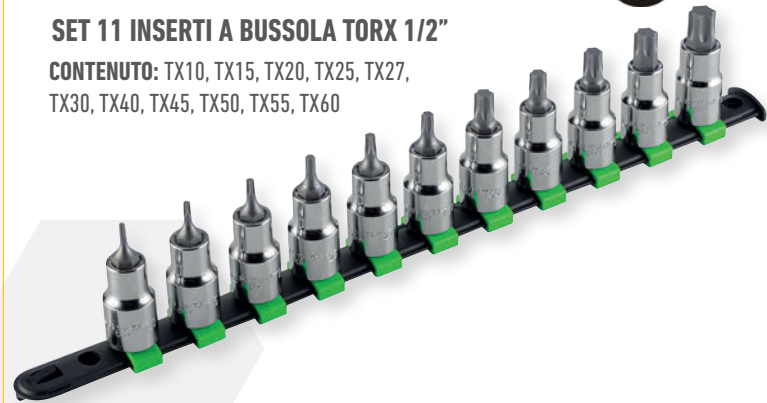

~~145,00€~~ 85,00€

## FG 625TX/S23

### SET CHIAVI A BUSSOLA TX E INSERTI A BUSSOLA TX

~~200,00€~~ 99,00€



FG 624/TX4, TX5, TX6, TX7, TX8, TX10



FG 625/TX12, TX14, TX16, TX18, TX20, TX22, TX24



FG 150/TX10, TX15, TX20, TX25, TX27, TX30, TX40



FG 625/CR12



FG 625/PA125



# CHIAVI A BUSSOLA



## FG 150TX/S32

SET 32 INSERTI A BUSSOLA TORX DA 1/2"

~~166,80€~~ **99,00€**



FG 150/TX20 - TX70



FG 150L/TX20 - TX70



FG 150XL/TX40 - TX70



FG 150XXL/TX40 - TX70



## FG 150M/S26

SET 26 INSERTI A BUSSOLA XZN DA 1/2"

~~160,80€~~ **99,00€**



FG 150/M5 - M16



FG 150L/M5 - M16



FG 150XL/M5 - M14



FG 150XXL/M8 - M14



## FG 150H/S30

SET 30 INSERTI A BUSSOLA ESAGONALI DA 1/2"

~~180,80€~~ **109,00€**



FG 150/H5 - H19



FG 150L/H5 - H13



FG 150XL/H5 - H14



FG 150XXL/H5 - H12

## FG 625/CR12

CRICCHETTO REVERSIBILE DA 1/2"  
- MECCANISMO 72 DENTI



~~42,00€~~ **24,90€**

## FG 625/RT12

CRICCHETTO REVERSIBILE  
DA 1/2" CON IMPUGNATURA  
ROTANTE - 60 DENTI



~~65,00€~~ **39,00€**

## 1/2"



## FG 625/FR12

CRICCHETTO REVERSIBILE DA 1/2"

- Modello con testa chiusa anti polvere
- Leva di inversione integrata a filo testa
- Corpo scavato di 13° per consentire l'utilizzo anche in spazi particolarmente difficili
- Meccanismo a 72 denti
- Cromatura lucida
- Asola di aggancio

~~49,00€~~ **29,90€**

## 3/4"



## FG 629A/S15

SET BUSSOLE ESAGONALI  
DA 3/4" + ACCESSORI

~~490,00€~~ **289,00€**



19,22,23,27,30,32  
36,41,46,50, 60mm



FG 629/CR34



FG 629/SN34



FG 629/ES34



FG 629/PR200

## FG 629B/S15

SET BUSSOLE POLIGONALI  
DA 3/4" + ACCESSORI

~~490,00€~~ **289,00€**

## FG 628/S10

SET 10 CHIAVI A BUSSOLA RINFORZATE  
DA 1/2" SU SUPPORTO IN PLASTICA

CONTENUTO: 10, 11, 12, 13, 15, 16, 17, 18, 19, 21 mm

~~85,00€~~ **49,90€**



## FG 152RH/S9

~~108,00€~~ **65,00€**

CONTENUTO: 5-19mm



## FG 152/RTXS10

~~150,00€~~ **89,00€**

SET 10 INSERTI A BUSSOLA  
RINFORZATI TORX DA 1/2"

CONTENUTO: TX20-TX70







# GIRAVITI E PINZE

## FG 22/S6

**CONTENUTO:** 3x75, 4x100, 5.5x100,  
PH0x60, PH1x80, PH2x100



~~29,58€~~

17,90€

## FG 22/S8

**CONTENUTO:** 3x75, 4x100, 5.5x100, 6.5x30  
PH0x60, PH1x80, PH2x100, PH2x30



~~39,08€~~

23,90€

## FG 22/S8B

**CONTENUTO:** 2.5x75, 3.5x100,  
4x100, 6.5x150, 8x150, PH0x60,  
PH1x80, PH2x150



~~42,08€~~

25,90€

## FG 22/S10

**CONTENUTO:** 2.5x60, 3x75, 4x100,  
5.5x150, 6.5x150, 4x30 PH0x60, PH1x80,  
PH2x100, PH1x30



~~55,08€~~

32,90€

## FG 22/S12

**CONTENUTO:** 2.5x60, 3x75, 4x100, 5.5x150,  
6.5x150, 8x150, 4x30, PH0x60, PH1x80,  
PH2x100, PH3x150, PH1x30



~~76,58€~~

45,90€

## FG 22TX/S6

**CONTENUTO:** TX10, TX15, TX20, TX25, TX27,  
TX30



~~56,08€~~

33,50€



## FG 139/B

SET 10 CHIAVI MASCHIO A L  
ESAGONALI - SERIE CORTA

1,5,2,2,5,3,4,5,5,6,8,10mm

~~13,50€~~ **7,90€**

## FG 139/C

SET 10 CHIAVI MASCHIO A L  
ESAGONALI - SERIE LUNGA

1,5,2,2,5,3,4,5,6,8,10mm

~~20,00€~~ **10,90€**



## FG 139/D

SET 10 CHIAVI MASCHIO A L  
ESAGONALI - SERIE CORTA

1,5,2,2,5,3,4,5,5,6,8,10mm

~~18,00€~~ **9,90€**

## FG 139/E

SET 10 CHIAVI MASCHIO A L  
ESAGONALI - SERIE LUNGA

1,5,2,2,5,3,4,5,6,8,10mm

~~28,00€~~ **16,90€**



## FG 139

SET 12 CHIAVI MASCHIO A L  
ESAGONALI - SERIE SFERICA

1,5,2,2,5,3,4,4,5,5,5,6,7,8,10mm

~~29,00€~~ **16,90€**

## FG 139/L

SET 12 CHIAVI MASCHIO A L  
ESAGONALI - SERIE LUNGA

1,5,2,2,5,3,4,4,5,5,5,6,7,8,10mm

~~33,00€~~ **19,90€**



## FG 139/S9

SET 9 CHIAVI MASCHIO A L  
ESAGONALI E LATO CORTO 110°

CONTENUTO: 1,5 - 10,0mm

~~32,00€~~ **19,90€**



## FG 138/BP

SET 9 CHIAVI MASCHIO  
TORX A L E TESTA SFERICA

CONTENUTO:

TX8,10,15,20,25,27,30,40,50

~~50,00€~~ **29,90€**

**TESTA  
SFERICA**



## FG 138

SET 12 CHIAVI  
MASCHIO TORX A L

CONTENUTO:

TX7,X8, 9, 10,15,20,25,27,30,40,45, 50

~~46,00€~~ **27,90€**



# GIRAVITI E PINZE

**FG 139/LM**

SET 10 CHIAVI MASCHIO A L ESAGONALI - SERIE LUNGA

CONTENUTO: 1.5, 2, 2.5, 3, 4, 5, 6, 7, 8, 10mm

~~43,00€~~ **25,90€**

ESTREMITÀ  
MAGNETICA



**FG 138/M**

SERIE 10 CHIAVI MASCHIO A L TORX

CONTENUTO: TX9 - TX50

~~52,50€~~ **31,90€**

ESTREMITÀ  
MAGNETICA



**FG 142/S9**

SET 9 CHIAVI MASCHIO CON IMPUGNATURA E IMPRONTA ESAGONALE

CONTENUTO: 2, 2.5, 3, 4, 5, 6, 7, 8, 10 mm

~~107,00€~~ **59,90€**



**FG 143TX/S6**

SET CHIAVI MASCHIO CON IMPUGNATURA E IMPRONTA TORX

CONTENUTO: TX10, TX15, TX20, TX25, TX30, TX40

~~67,00€~~ **39,90€**



**FG 86/S56**

SET 56 UTENSILI ASSORTITI



~~150,00€~~ **90,00€**

**FG 58/A240**

PINZA REGOLABILE A CERNIERA CHIUSA CON PULSANTE DI SGANCIO RAPIDO

L: 240mm - 9.5"



~~36,00€~~ **19,90€**



**FG 59SR/S3**

SET 3 PINZE, DOTATE DI MOLLA SOFT-RUN

FG 59SR/160, FG 61SR/160, FG 63SR/160

~~70,00€~~ **41,90€**



**FG 59PV/S3**

SET 3 PINZE, CON MANICI IN DOPPIO STRATO DI PVC

FG 59PV/160, FG 61PV/160, FG 63PV/160

~~60,00€~~ **35,90€**



**FG 51/S4**

SET 4 PINZE PER ANELLI ELASTICI 8-25MM

~~81,00€~~ **48,50€**



**FG 51/S4B**

SET 4 PINZE PER ANELLI ELASTICI 19-60MM

~~87,00€~~ **52,50€**



**"INSERTI RINFORZATI PER ANELLI DI GRANDE TENUTA"**



**FG 55/S4**

SET 4 PINZE PER ANELLI ELASTICI CON INSERTI RINFORZATI IN ACCIAIO 10-25MM

~~118,00€~~ **69,50€**

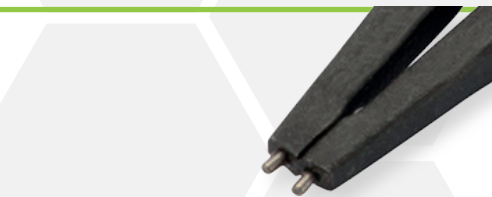

**FG 55/S4B**

SET 4 PINZE PER ANELLI ELASTICI CON INSERTI RINFORZATI IN ACCIAIO 19-60MM

~~122,00€~~ **72,50€**





**FG 603/S28A**

**FG 603/S28B**

**KIT 26 UTENSILI ISOLATI, COMPLETO DI  
ELMETTO DIELETTRICO E  
GUANTI DIELETTRICI 1.000V**



**IDEALE PER INTERVENTI SU  
VEICOLI ELETTRICI ED IBRIDI**



CODICE	TAGLIA GUANTI	LISTINO	€/PROMO
FG 603/S28A	TAGLIA 9	878,00	439,00
FG 603/S28B	TAGLIA 10	878,00	439,00



FG 59/IS200



FG 61/IS200



FG 63/IS160



FG 603/E10,11,12,  
13,14,17,19



FG 625E/10,11,12,  
13,14,17,19



FG 22E/4X100, 5.5X125,  
FG22E/PH1X80, PH2X100



FG 625E/CR12



FG 625E/PR250



FG 49/E



FG 48/IS



FG 22/CF250

**FG 603/TA1**

**TAPPETO ISOLANTE 1000V**  
- 1.000x1.000x4mm

~~240,00€~~

**129,00€**



## FG 22E/S6

### SET 6 GIRAVITI ISOLATI

CONTENUTO: 3x100, 4x100, 5.5x125, PH0x60, PH1x80, PH2x100



1000V  
IEC 60900



~~48,90€~~ 29,90€

## FG 22E/SZ6

### SET 6 GIRAVITI ISOLATI

CONTENUTO: 3x100, 4x100, 5.5x125, PZ0x60, PZ1x80, PZ2x100



1000V  
IEC 60900



~~48,90€~~ 29,90€



## FG 59IS/S3

### SET 3 PINZE CON MANICI ISOLATI

~~102,80€~~ 56,90€

1000V  
IEC 60900



## FG 68U/S439

### SET PINZA UNIVERSALE + 3 MATRICI E 436 CAPICORDA ISOLATI

~~260,80€~~ 159,00€



## FG 96/DG

### MULTIMETRO DIGITALE DC/AC - OHM

~~165,00€~~ 99,00€

#### FUNZIONI AGGIUNTIVE:

- MISURAZIONE TEMPERATURA
- MISURAZIONE DI UMIDITÀ
- MISURAZIONE LUX
- MISURAZIONE DEL SUONO



#### FUNZIONE

DC	0.4V, 4V, 40V, 400V, 600V (± 0.7%)
AC	4V, 40V, 400V, 600V (± 0.8%)
Ω	400 Ω, 4K Ω, 400kΩ, 4MΩ (± 1.2) 40MΩ (± 2.0%)
CAPACITA'	4nF, 40nF, 400nF, 4μF, 40 μF, 200 μF (± 3.0%)
FREQUENZA	10Hz, 100Hz, 1kHz, 10kHz, 100kHz (± 2.0%)
DUTY CYCLE	0.1% - 99.9% (± 3.0%)
TEST DI CONTINUITA'	si/si/yes
PROVA DIODI	si/si/yes
TEMPERATURA	-20°C - 400°C (± 3.0% / 0.1°C) -20°C - 1.000°C (± 3.0% / 1°C)
CAPACITA' RILEVAZIONE UMIDITA'	30% - 95% RH ((± 5.0%))
LUX	4.000 Lux / 40.000 Lux ((± 5.0%))
CAPACITA' RILEVAZIONE SUONO	35 - 100dB ((± 4dB))
STANDBY	Dopo 15 minuti
INDICATORE LIVELLO BATTERIA	Si
BATTERIA	9V
DIMENSIONE	8x3.5x16.5H mm

## CHIAVI DINAMOMETRICHE PER SERRAGGI DESTROSI

PRECISIONE DI SERRAGGIO:  $\pm 4\%$

IMPUGNATURA ERGONOMICA IN POLIPROPILENE SOFT-TOUCH

QUADRANTE CON DOPPIA SCALA NM E LBS CON NUMERI DI FACILE LETTURA

SISTEMA DI REGOLAZIONE CONTROLLATO CON AVVICINAMENTO SOFT

SISTEMA DI INVERSIONE A GHIERA INTEGRATO SULLA TESTA

CROMATURA LUCIDA

MECCANISMO INTERNO INTERAMENTE IN ACCIAIO DOTATO DI CUSCINETTO A SFERE

MECCANISMO A 72 DENTI CON 5° DI RIPRESA



### CHIAVI DINAMOMETRICHE A DISINNESTO E ATTACCO QUADRO

CODICE	RISOLUZIONE	NM	LISTINO	€/PROMO	
FG 531	0.1Nm	5-25Nm	175,00	99,00	1/4"
FG 533/2	0.25Nm	10-50Nm	189,00	112,50	3/8"
FG 536/1	0.5Nm	20-100Nm	195,00	116,00	1/2"
FG 536/2	1.0Nm	40-200Nm	216,00	119,00	1/2"
FG 536/3	2.0Nm	60-340Nm	225,00	135,00	1/2"



### CHIAVI DINAMOMETRICHE DIGITALI PER NM E GRADI

1/2"

CODICE	NM	LISTINO	€/PROMO
FG 543/DG1	16.8-135	580,00	349,00
FG 543/DG2	10-200	610,00	365,00

- Doppia modalità di misurazione: PICCO e TRACCIA
- Indicatore sonoro e visivo a 12 led al raggiungimento della coppia prefissata
- Possibilità di memorizzare fino a 250 differenti serraggi grazie al software PC incluso nel kit Interfaccia PC tramite presa USB
- Possibilità di impostare fino a 9 serraggi predefiniti
- Alimentazione: 2 batterie 1.5V (incluse)





**CHIAVE DINAMOMETRICA  
AD INNESTO FEMMINA 9X12MM**

CODICE	NM	RES	L/MM	LISTINO	€/PROMO
FG 544/1	5-25	1.0	259	230,00	139,00
FG 544/2	10-50	0.25	385	195,00	119,00
FG 544/3	20-100	0.5	385	210,00	129,00

**CHIAVE DINAMOMETRICA  
AD INNESTO FEMMINA 14X18MM**

Precisione: ± 3%

CODICE	NM	RES	L/MM	LISTINO	€/PROMO
FG 544/4	40-200	1.0	480	250,00	149,00



**FG 547/DG**

**GONIOMETRO DIGITALE  
PER SERRAGGI ANGOLARI**

Precisione di serraggio: ± 2%



CODICE	GRADI	A/MM	H/MM	LISTINO	€/PROMO
FG 547/DG	1-360	58	41	160,00	92,50

**FG 580/A**

**MINI MOLTIPLICATORE DI  
COPPIA DESTORSO/SINISTRORSO**

1/2"x1/2" Rapporto: 3.4:1

~~250,00€~~ **149,00€**



**FG 580/B**

**MINI MOLTIPLICATORE DI  
COPPIA DESTORSO/SINISTRORSO**

1/2"x3/4" Rapporto: 3.4:1

~~340,00€~~ **199,00€**

**BARRE DINAMOMETRICHE A  
DISINNESTO E ATTACCO QUADRO**

CODICE	NM	LISTINO	€/PROMO
FG 538/1	3/4"	140-560	399,00
FG 538/2	3/4"	200-800	449,00
FG 539/1	1"	200-1.000	579,00

GRADO DI PRECISIONE: ± 4%



FORNITA IN CASSETTA DI ABS





# MANUTENZIONE GENERALE



**FG 70/S110**

**SET MASCHI E FILIERE IN ACCIAIO AL CROMO + ACCESSORI - 110PZ**  
PASSO GROSSO E FINE - FILETTATURA METRICA

~~300,00€~~

**179,00€**

## ACCESSORI

2x.04	6x0.75	12x1	2x0.4	6x0.75	12x1	GF25x9
3x0.5	7x0.75	12x1.25	3x0.5	7x0.75	12x1.25	GF8x14
4x0.7	8x0.75	12x1.5	4x0.7	8x0.75	12x1.5	GMM1.5
5x0.8	8x1	14x1	5x0.8	8x1	14x1	GMM3
6x1	9x0.75	14x1.25	6x1	9x0.75	14x1.25	GMC1
7x1	9x1	14x1.5	7x1	9x1	14x1.5	
8x1.25	10x0.75	16x1	8x1.25	10x0.75	16x1	
9x1.25	10x1	16x1.5	9x1.25	10x1	16x1.5	
10x1.5	10x1.25	18x1.5	10x1.5	10x1.25	18x1.5	
11x1.5	11x0.75		11x1.5	11x0.75		
12x1.75	11x1		12x1.75	11x1		
14x2	11x1.25		14x2	11x1.25		
16x2	12x0.75		16x2	12x0.75		



**FG 75HSS/S25**

**SET 25 PUNTE ELICOIDALI CILINDRICHE IN ACCIAIO HSS RETTIFICATE**  
1 - 13 X0,5MM

~~122,00€~~

**69,00€**



**FG 75TIN/S25**

**SET 25 PUNTE ELICOIDALI CILINDRICHE IN ACCIAIO HSS -TIN 5% RETTIFICATE**  
1 - 13 X0,5MM

~~169,00€~~

**99,00€**



**FG 75CO/S25**

**SET 25 PUNTE ELICOIDALI CILINDRICHE IN ACCIAIO HSS-COBALTO 5% RETTIFICATE**  
1 - 13 X0,5MM

~~205,00€~~

**119,00€**



**FG 78HSS/S12**

**SET 9 FRESE A TAZZA IN ACCIAIO HSS BI-METAL + ACCESSORI**

~~200,00€~~

**119,00€**

## FG 48/L

CUTTER PROFESSIONALE  
A LAMA LUNGA



~~8,00€~~ 4,90€

## FG 48/LG

CUTTER PROFESSIONALE  
A LAMA LUNGA



~~8,00€~~ 4,90€

## FG 48/L9

NEW

CUTTER EXTRA PIATTO CON LAMA  
A SETTORI 9MM

- CORPO IN ACCIAIO INOX
- FORNITO CON UNA LAMA



~~6,50€~~ 3,90€

## FG 48/B

CUTTER A SERRAMANICO  
CON LAMA TRAPEZOIDALE

- CON 3 LAME DI RICAMBIO



~~19,80€~~ 11,50€

## FG 49/TC

FORBICE DA ELETTRICISTA,  
DOTATA DI INCAVO SPELLAFILI  
E CORPO INTEGRALMENTE IN ACCIAIO

- L/MM 140 - A/MM 65MM
- LAMA MICRODENTATA IN ACCIAIO
- HRC: 56
- STRUTTURA INTEGRALE IN ACCIAIO INOX
- TAGLIACAVI 12MM
- CON SUPPORTO PER CINTURA

~~33,50€~~ 19,90€



STRUTTURA INTERAMENTE  
IN ACCIAIO FORGIATO

## FG 49/TCX

FORBICE DA ELETTRICISTA, DOTATA  
DI INCAVO SPELLAFILI E CORPO  
INTEGRALMENTE IN ACCIAIO

- L/MM 160 - A/MM 50MM
- LAMA MICRODENTATA IN ACCIAIO
- HRC: 56
- STRUTTURA INTEGRALE IN ACCIAIO INOX
- TAGLIACAVI 15MM
- CON SUPPORTO PER CINTURA

~~42,80€~~ 25,50€



STRUTTURA INTERAMENTE  
IN ACCIAIO FORGIATO

## FG 77/PVC4

TRONCATUBI A CRICCO

- SISTEMA A CREMAGLIERA CON  
AVANZAMENTO PROGRESSIVO
- DOTATA DI PIATTAFORMA IN NYLON CHE  
FACILITA IL TAGLIO DI PROFILI PIATTI
- Ø: 0-42MM



~~65,00€~~ 39,00€

## FG 49/MU

FORBICE MULTIUSO CON GOLA SPELLAFILI  
E LAME IN ACCIAIO INOX ZIGRINATE

- L/MM 203 - LAMA 52MM - SPELLAFILI 1.0, 1.5, 2.0 MM<sup>2</sup>



HRC: 52-54

~~21,00€~~ 12,50€



# MANUTENZIONE GENERALE

**FG 127/S1**

SET SCALPELLI E PUNZONI



~~40,00€~~

**23,90€**

**FG 128/S11**

SET 11 UTENSILI DA PERCUSSIONE CON IMPUGNATURA



~~108,50€~~

**59,90€**

**FG 95/CA**

CALIBRO A CORSOIO, LETTURA CINQUANTESIMALE

- L/MM: 150



~~42,00€~~

**24,90€**

**FG 95/DG**

CALIBRO A CORSOIO, DIGITALE

- L/MM: 150



~~76,00€~~

**44,90€**



FLESSOMETRO CON CASSA IN ABS ANTI-SHOCK E NASTRO IN ACCIAIO RIVESTITO IN NYLON CLASSE II

CODICE	L/MM	BANDA	LISTINO	€/PROMO
FG 44/MT3	3	16MM	9,00	5,50
FG 44/MT5	5	25MM	14,50	8,90
FG 44/MT8	8	25MM	20,50	12,50
FG 44/MT10	10	25MM	24,50	14,90

**FG 97/T1**

TERMOMETRO DIGITALE AD INFRAROSSI

RANGE DI MISURAZIONE

-32°C ~ 760°C / -25°F ~ 1.400°F



~~233,00€~~

**139,00€**

**FG 97/T2**

TERMOMETRO DIGITALE AD INFRAROSSI

RANGE DI MISURAZIONE

-32°C ~ 1.650°C / -25°F ~ 3.002°F

~~579,00€~~

**249,00€**

CE

FG 712/L4

**NEW**

## PORTA MINUTERIE A RIPIANI GIREVOLI

- FORNITO CON DIVISORI INTERNI
- DOTATO DI 4 RIPIANI GIREVOLI E VASCHETTA SUPERIORE PORTA MINUTERIE
- MATERIALE: ABS RESISTENTE AGLI URTI
- DOTATO DI 4 PIEDI D'APPOGGIO

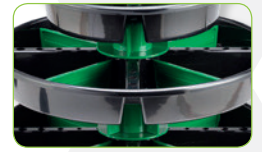

~~130,00€~~

**79,00€**

FG 92/PM4

## PROLUNGA MAGNETICA TELESCOPICA (165-622MM)

~~25,00€~~

**11,90€**



FG 92/PF

## PROLUNGA MAGNETICA CON ASTA FLESSIBILE

~~25,00€~~

**11,90€**

LUNGHEZZA  
ASTA: 400MM



FG 92/PM

## PROLUNGA MAGNETICA CON ASTA FLESSIBILE

~~16,50€~~

**9,90€**



1 metro

ASTA  
DA 1 METRO

Ø: 3.9mm

FG 93/M50

## SPECCHIETTO TELESCOPICO E ARTICOLATO IN ACCIAIO

~~27,80€~~

**16,90€**

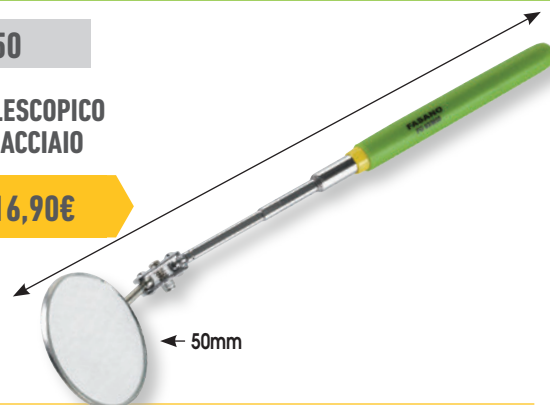

50mm

FG 93/M95

## SPECCHIETTO TELESCOPICO E ARTICOLATO IN ACCIAIO

~~27,80€~~

**16,90€**

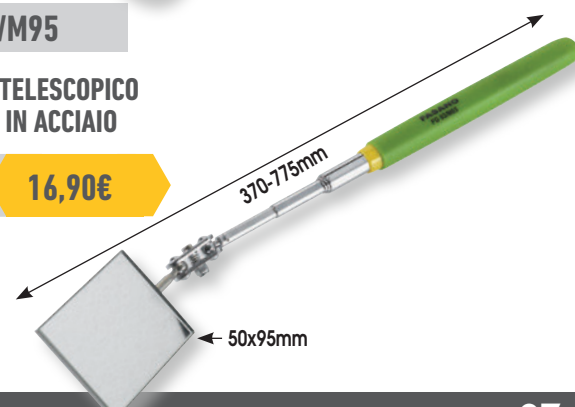

370-775mm

50x95mm



# MANUTENZIONE GENERALE

FG 207

NEW



LAMPADA RICARICABILE A LED

~~60,00€~~

29,90€



TOP LED DI PUNTAMENTO



FG 206

NEW



LAMPADA RICARICABILE A LED

~~50,00€~~

25,90€



## EXTRA-PIATTA



FG 208

NEW

LAMPADA SOTTO COFANO RICARICABILE A LED

LUNGHEZZA REGOLABILE:  
1.300-2.060MM

LAMPADA PORTATILE  
INTEGRATA E REMOVIBILE

DUE PRODOTTI IN 1



CORDLESS LAMP  
200 LUMEN

DOTATA DI SISTEMA  
MAGNETICO



~~240,00€~~

129,00€



FG 211

~~98,50€~~

59,00€

LAMPADA  
RICARICABILE A LED

CE

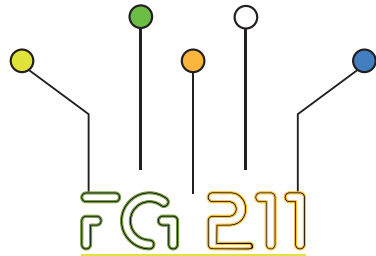

TOP LED DI  
PUNTAMENTO



ORIENTABILITÀ  
A 360°



REGOLATORE  
D'INTENSITÀ



INDICATORE  
DI CARICA



BASE MAGNETICA E  
GANCIO ESTRAIBILE

FG 212

~~70,00€~~

39,00€

LAMPADA  
RICARICABILE A LED

CE



FG 210/A

MINI FARETTO  
PORTATILE A LED

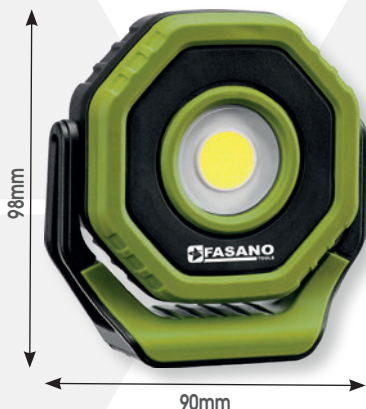

~~75,00€~~

49,00€

CE





# VALIGIE PORTA UTENSILI

CE



FG 98/GAS

## SALDATORE PORTATILE A GAS

- TEMPERATURA MAX: 210-450°C
- 25 WATT
- CAPACITÀ: 120 MIN CONTINUATIVI
- FORNITO CON PUNTE PER SALDARE, TAGLIARE E SOFFIARE

~~105,00€~~

62,90€

CE

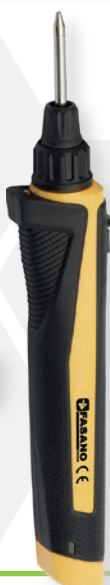

FG 98/LT

## SALDATORE PORTATILE CON BATTERIA AL LITIO

- TEMPERATURA MAX: 600°C
- AUTONOMIA: 40MIN CONTINUATIVI
- TEMPO DI RICARICA: 3.5H
- FORNITO CON PUNTE PER SALDARE, TAGLIARE E SOFFIARE

~~245,00€~~

139,00€

FG 111/A

## CASSETTA PORTA-UTENSILI A 3 SCOMPARTI

~~50,00€~~

29,90€

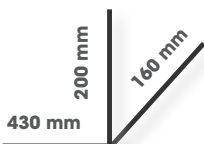

FG 111/B

## CASSETTA PORTA-UTENSILI A 5 SCOMPARTI

~~60,00€~~

35,90€

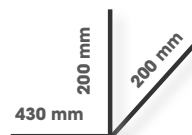

FG 111/C

## CASSETTA PORTA-UTENSILI A 5 SCOMPARTI

~~72,00€~~

42,90€

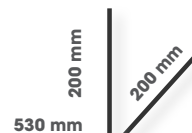

FG 111/AS55

**NEW**

CASSETTA PORTA-UTENSILI FG 111/C CON 5  
SCOMPARTI CON ASSORTIMENTO 55 UTENSILI

~~570,00€~~

**199,00€**



PER IL CONTENUTO CONSULTARE  
PAGINA 269 DEL CATALOGO GENERALE

FG 111/AS104

**NEW**

CASSETTA PORTA-UTENSILI FG 111/C CON 5  
SCOMPARTI CON ASSORTIMENTO 104 UTENSILI

~~680,00€~~

**299,00€**



PER IL CONTENUTO CONSULTARE  
PAGINA 269 DEL CATALOGO GENERALE





# ESTRATTORI



**FG 162/S3**

SET 3 ESTRATTORI A 2 GRIFFE  
- 27-90MM, 27-135MM, 35-155MM

~~285,00€~~ **169,00€**



**FG 163/S2B**

ESTRATTORE A 3 GRIFFE PER PRESA ESTERNA + GRIFFE PER PRESA INTERNA  
- APERTURA MAX PER PRESA ESTERNA: 7-140MM  
- APERTURA MAX PER PRESA INTERNA: 50-70MM

~~230,00€~~ **129,00€**



**FG 165/...**

## ESTRATTORE AUTOCENTRANTE A 3 GRIFFE

- POSSIBILITÀ DI 4 POSIZIONI DIFFERENTI
- PRESA ESTERNA
- MECCANISMO AUTOCENTRANTE
- GRIFFE CON APERTURA PER CONSENTIRE UNA MIGLIOR PRESA SU BULLONI SPECIALI

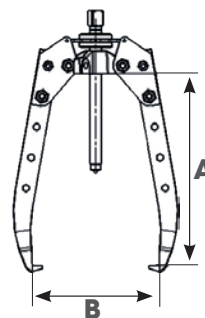

CODICE	A/MM	B/MM	LISTINO	€/PROMO
FG 165/1	120	125	250,00	153,50
FG 165/2	210	220	320,00	189,00
FG 165/3	270	280	470,00	279,00

**FG 165/HI**

## ESTRATTORE IDRAULICO AUTOCENTRANTE A 3 GRIFFE

- POSSIBILITÀ DI 4 POSIZIONI DIFFERENTI
- PRESA ESTERNA
- MECCANISMO AUTOCENTRANTE
- GRIFFE CON APERTURA PER CONSENTIRE UNA MIGLIOR PRESA SU BULLONI SPECIALI

CODICE	LISTINO	€/PROMO
FG 165/HI	870,00	529,00

- A/MM: 270
- B/MM: 280
- C/MM: 4.5

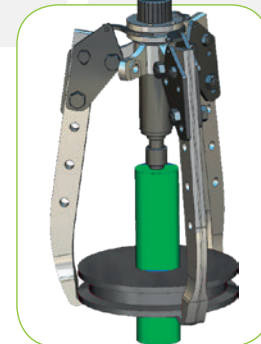
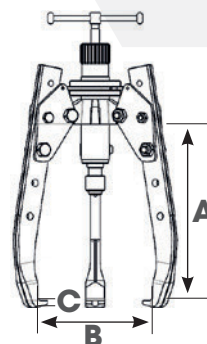



### ESTRATTORE A 2/3 GRIFFE

- DOTATO DI 3 GRIFFE PER PRESA INTERNA E 3 GRIFFE PER PRESA ESTERNA
- GRIFFE IN ACCIAIO CROMO VANADIO

CODICE	Ø INTERNAL	Ø ESTERNA	LISTINO	€/PROMO
FG 165/IE1	25-100MM	0-75MM	288,00	169,00
FG 165/IE2	45-150MM	40-130MM	688,00	409,00



### MASSA BATTENTE

CODICE	L/MM	PESO	LISTINO	€/PROMO
FG 165/MB1	360	1KG	158,00	89,00
FG 165/MB2	200+400	2KG	298,00	175,00

L/mm



### FG 168/FS5

SET 5 ESTRATTORI CONICI PER VITI E PRIGIONIERI SPEZZATI

~~16,50€~~ 9,90€



### FG 168EP/S5

SET 5 ESTRATTORI CONICI PER VITI E PRIGIONIERI SPEZZATI  
- INSERIMENTO A PERCUSSIONE

~~26,50€~~ 15,90€



### FG 168/S25

SET ESTRATTORI PER VITI E PRIGIONIERI SPEZZATI

- DOTATO DI GUIDE PER INTERNO ED ESTERNO E PUNTE PER FORARE
- PER VITI/BULLONI CON DIAMETRO 6-16MM

~~120,00€~~ 72,50€



### FG 182/S10

SET ESPANSORI A SETTORE PER INTERNI CON ACCESSORI

~~760,00€~~ 399,00€



### FG 182/S14

SET ESTRATTORI PER CUSCINETTI CON FALSE SFERE

- ØMM: 5, 6, 8, 9, 11, 12,5

~~195,00€~~ 119,00€



## UTENSILI PNEUMATICI



**QUALITA'**

GLI UTENSILI SONO PRODOTTI  
DALLA SCELTA DEI MIGLIORI  
MATERIALI DISPONIBILI



**ASSISTENZA**

SUPPORTO COSTANTE E MASSIMA  
DISPONIBILITÀ NEI CONFRONTI  
DEL CLIENTE



**RICERCA**

GRANDE CAPACITÀ NELL'ANTICIPARE  
LE ESIGENZE DEL MERCATO

## PNEUMATIC TOOLS

LA GAMMA DI UTENSILI PNEUMATICI FASANO TOOLS SI CARATTERIZZA  
PER ELEVATE PRESTAZIONI E GRANDE AFFIDABILITÀ NEL TEMPO.

LA PROPOSTA FASANO TOOLS È DEDICATA SIA AL SETTORE AUTOMOTIVE  
CHE A QUELLO INDUSTRIALE, E ALCUNI DEGLI ARTICOLI PRESENTI  
IN GAMMA SI DISTINGUONO PER ELEMENTI UNICI E ALTAMENTE  
PERFORMANTI.

PER TUTTI GLI UTENSILI FASANO TOOLS GARANTISCE LA COSTANTE  
DISPONIBILITÀ DI RICAMBI NEL TEMPO ED UN SERVIZIO DI  
MANUTENZIONE ALTAMENTE QUALIFICATO E RAPIDO.



CE



COPPIA DI SPUNTO



MARTELLO SINGOLO



FGA 307

~~225,00€~~

135,00€

AVVITATORE AD IMPULSI-1/2"



CE



COPPIA DI SPUNTO



MARTELLO DOPPIO



FGA 309

~~270,00€~~

159,00€

AVVITATORE AD IMPULSI-1/2"



CE



COPPIA DI SPUNTO



MARTELLO DOPPIO



FGA 312

~~335,00€~~

199,00€

AVVITATORE AD IMPULSI-1/2"



CE



MARTELLO DOPPIO



FGA 302

~~220,00€~~

119,00€

AVVITATORE AD IMPULSI-1/2"



# UTENSILI PNEUMATICI

**FGA 316**

~~665,00€~~ **399,00€**

AVVITATORE AD IMPULSI-3/4"

**FGA 316/L**

~~735,00€~~ **449,00€**

AVVITATORE AD IMPULSI - 3/4"  
AD ALBERO LUNGO 6"

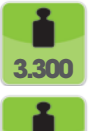

MARTELLINO DOPPIO



**FGA 321**

~~950,00€~~ **559,00€**

AVVITATORE AD IMPULSI -1"

**FGA 321/B**

~~1.000,00€~~ **589,00€**

AVVITATORE AD IMPULSI 1"  
AD ALBERO LUNGO 6"



MARTELLINO DOPPIO



**FGA 319**

~~1.050,00€~~ **559,00€**

AVVITATORE AD IMPULSI -1"

**FGA 319/L**

~~1.150,00€~~ **619,00€**

AVVITATORE AD IMPULSI 1"  
AD ALBERO LUNGO 6"



PIN-LESS





PIN-LESS

**FGA 321/C** **NEW**

AVVITATORE AD IMPULSI 1" AD ALBERO LUNGO 6"

~~1.100,00€~~ **599,00€**

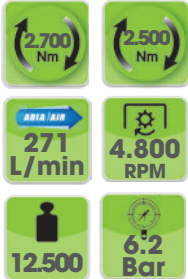

IDEALE PER UTILIZZI INTENSIVI



**FGA 291/B**

MINI-CRICCHETTO REVERSIBILE DA 1/4"



~~115,00€~~ **59,00€**



**FGA 292/B**

CRICCHETTO REVERSIBILE 1/2"



~~200,00€~~ **119,00€**



COPPIA TORCENTE



**FGA 307AN/S13**

KIT COMPOSTO DA AVVITATORE ANGOLARE E SERIE DI 12 CHIAVI A BUSSOLA EXTRA PIATTE



COPPIA DI SPUNTO

MARTELLO SINGOLO



Pulsante di avviamento

Sistema di reversibilità



Corpo ultra compatto

Scarico aria centrale

Doppio livello di velocità regolabile

~~315,00€~~ **189,00€**

**+ OMAGGIO**

**FGA 628/S12**

SET 12 CHIAVI A BUSSOLA RINFORZATE 1/2"



CONTENUTO: 10, 11, 12, 13, 14, 15, 16, 17, 18, 19, 20, 21 mm



# UTENSILI PNEUMATICI

FGA 332

TRAPANO REVERSIBILE CON  
MANDRINO AUTOSERRANTE 1-10MM



~~133,00€~~ 79,00€

FGA 333

TRAPANO REVERSIBILE CON  
MANDRINO AUTOSERRANTE 1-13MM



~~172,50€~~ 99,00€

FGA 333/AC

TRAPANO REVERSIBILE CON  
MANDRINO IN ACCIAIO 1-13MM

~~195,00€~~ 119,00€



FGA 332/AN

TRAPANO ANGOLARE  
MANDRINO AUTOSERRANTE  
1-10MM

~~160,00€~~ 96,00€



FGA 340

- ø orbita: 5.0mm  
- platorello 15 fori

~~270,00€~~ 149,00€



FGA 340/B

~~270,00€~~ 149,00€

- ø orbita: 2.5mm  
- platorello 15 fori



FGA 342/B

LEVIGATRICE  
ROTO-ORBITALE  
- ø orbita: 2.5mm  
- platorello 3 fori



~~260,00€~~ 159,00€



## FGA 337

LEVIGATRICE PNEUMATICA  
PER RIMOZIONE RESIDUI GOMMOSI



~~115,00€~~

69,00€

## FGA 330

SEGHETTO ALTERNATIVO



~~266,00€~~

149,00€

## FGA 339/B

LEVIGATRICE ANGOLARE  
- ø disco: 50mm

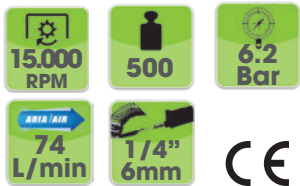

~~170,00€~~

99,00€

DISCHETTI PER FGA 339/B

CODICE	GRANA	LISTINO	€/PROMO
FGA 339/B50-G60	60	9,00	5,40
FGA 339/B50-G80	80	10,00	6,00
FGA 339/B50-G120	120	12,00	7,20

## FGA 339

LEVIGATRICE ANGOLARE  
- ø disco: 115mm



~~295,00€~~

179,00€

## FGA 335

RIVETTATRICE PNEUMATICA  
- 4 testine intercambiabili



~~180,00€~~

99,00€

## FGA 336

RIVETTATRICE PNEUMATICA  
- 4 testine intercambiabili



~~499,00€~~

299,00€





# UTENSILI PNEUMATICI

FGA 338

SMERIGLIATRICE DIRITTA A PINZA

~~115,00€~~ 62,50€

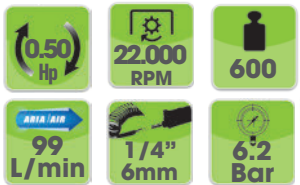

CE

## LAME ROTORE IN KEVLAR

FGA 334

SMERIGLIATRICE DIRITTA A PINZA

~~130,00€~~ 79,00€



CE

FGA 338/B

SMERIGLIATRICE DIRITTA A PINZA A BASSA VELOCITA'

~~145,00€~~ 89,00€

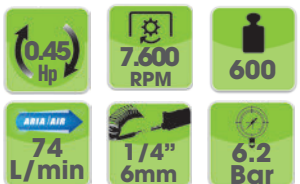

CE

FGA 334/AN115

SMERIGLIATRICE ANGOLARE A PINZA - INCLINAZIONE 115°



CE

~~165,00€~~ 99,00€

FGA 338/AN

SMERIGLIATRICE ANGOLARE A PINZA

~~155,00€~~ 92,50€



CE

FGA 334/AN

SMERIGLIATRICE ANGOLARE A PINZA



CE

~~165,00€~~ 99,00€

FGA 338/L

SMERIGLIATRICE DIRITTA A PINZA AD ALBERO LUNGO

~~148,50€~~ 89,00€



CE

FGA 334/AL

SMERIGLIATRICE DIRITTA A PINZA AD ALBERO LUNGO

~~165,00€~~ 99,00€



CE

## FGA 343/N10

CE

LEVIGATRICE A NASTRO  
- 10x330mm



~~205,00€~~ **119,00€**

## FGA 342

LEVIGATRICE ORBITALE  
- ø orbita: 2mm



~~180,00€~~ **109,00€**

## FGA 343/N20

CE

LEVIGATRICE A NASTRO  
- 20X520MM

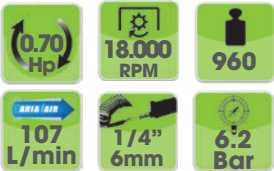

~~250,00€~~ **149,00€**

## FGA 346/S4

KIT COMPOSTO DA MICRO SMERIGLIATRICE  
ASSIALE E KIT 3 LIME ROTATIVE IN ACCIAIO DURO

~~166,00€~~ **99,00€**

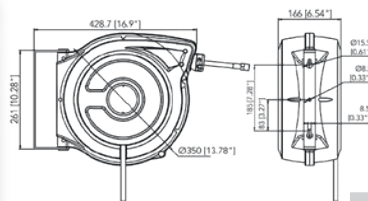

~~180,00€~~ **109,00€**

## FGA 382/AR15

AVVOLGITUBO AUTOMATICO  
PER ARIA COMPRESSA

- ø tubo interno: 8x12mm  
- Lunghezza tubo: 15metri

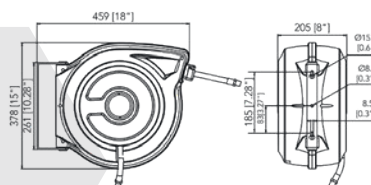

~~195,00€~~ **129,00€**

## FGA 384/AR15

AVVOLGITUBO AUTOMATICO  
PER ARIA COMPRESSA

- ø tubo interno: 11x16mm  
- Lunghezza tubo: 15metri



TUBO IN PVC ANTI-SCHIACCIAMENTO  
STAFFA A MURO ORIENTABILE A 360°

Guida di scorrimento  
automatico

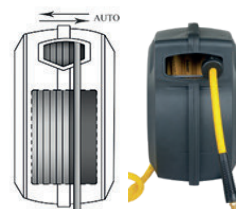

Sistema di bloccaggio  
a qualsiasi lunghezza

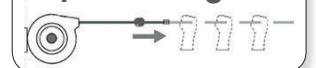

Riavvolgimento a  
velocità controllata

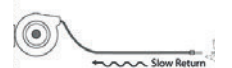



## AUTOMOTIVE

FASANO TOOLS PROPONE UNA GAMMA DI UTENSILI SPECIALI DEDICATI AL SETTORE AUTOMOTIVE, IN GRADO DI COPRIRE LE ESIGENZE QUOTIDIANE DI OGNI OPERATORE: DAL MONDO DELLA MECCANICA A QUELLO DEI GOMMISTI, DALLA CARROZZERIA FINO AD ARRIVARE ALLE PIÙ MODERNE APPLICAZIONI RELATIVE AI CAMBI AUTOMATICI O AI VEICOLI IBRIDI ED ELETTRICI.

FASANO TOOLS GARANTISCE ALLA PROPRIA CLIENTELA UN SERVIZIO TECNICO COSTANTE NON SOLO PER L'APPLICAZIONE DEI PROPRI UTENSILI, MA ANCHE PER LO SVILUPPO DI NUOVE SOLUZIONI.



**FG 175/S6**

SET 6 CHIAVI A TAZZA PER  
CARTUCCE FILTRI OLIO

~~55,00€~~

**32,90€**



**FG 175/S30**

SET 28 CHIAVI A TAZZA  
PER FILTRI OLIO

~~180,00€~~

**99,00€**

**FG 175/F074**

**NEW**

CHIAVE A TAZZA PER FILTRI OLIO  
FORD 1.0,2.0,2.3 ECOBOOST



**3/8"**

**FG 175/F074.5**

**NEW**

CHIAVE A TAZZA PER FILTRI OLIO  
FORD 1.5, 1.6 ECOBOOST



~~40,00€~~

**24,00€**

**FG 175/F084**

**NEW**

CHIAVE A TAZZA PER FILTRI OLIO  
MOTORI MERCEDES



**1/2"**

~~50,00€~~

**29,90€**

**FG 175/HI**

CHIAVE A TAZZA PER FILTRI OLIO  
MOTORE HYUNDAI TUCSON



**1/2"**

~~50,00€~~

**29,90€**

**FG 175/S114**

SET RIPARAZIONE  
TAPPI OLIO

- M13x1.25
- M13x1.5
- M15x1.5
- M17x1.5
- M20x1.5
- M22x1.5



~~225,00€~~

**135,00€**

**FG 178/UF**

IMBUTO UNIVERSALE  
PER OLIO



~~52,00€~~

**29,90€**



# AUTOMOTIVE

FG 203/S20

KIT PER IL CONTROLLO  
TENUTA DELL'IMPIANTO  
DI RAFFREDDAMENTO

~~330,00€~~ 195,00€



FG 203/BW1

BMW



FG 203/F01

FORD Fiesta  
dal 2008



FG 203/F02

FORD



FG 203/OP1

OPEL



FG 203/T01

TOYOTA

## TAPPI OPTIONAL

CODICE	LISTINO	€/PROMO
FG 203/BW1	30,00	17,90€
FG 203/F01	30,00	17,90€
FG 203/F02	30,00	17,90€
FG 203/OP1	30,00	17,90€
FG 203/T01	30,00	17,90€

21Pz

FG 203/A

NEW

CHIAVE A BUSSOLA PER  
SMONTAGGIO TAPPI RADIATORE

~~20,00€~~ 11,90€



3/8"



3mm

5mm



FG 203/S7

STRUMENTO PER IL RIEMPIMENTO A DEPRESSIONE DEI  
CIRCUITI DI RAFFREDDAMENTO

- Utile per effettuare uno spurgo  
perfetto grazie alla messa sotto  
vuoto del circuito di raffreddamento

~~140,00€~~ 83,90€



FG 176/S13

POMPA PER  
INSERIMENTO OLIO  
CAMBI E DIFFERENZIALI

Capacità 7,5 litri



~~380,00€~~ 219,00€



- Fornito di 12 accessori per connessione diretta  
- Dotato di valvola di non ritorno

FG 491/AD550

SIRINGA PER FLUIDI  
DOTATA DI DOPPIA  
MANDATA (IN & OUT)

500CC

~~115,00€~~ 69,00€

FG 491/DF1500

SIRINGA PER ESTRAZIONE  
CARBURANTE DEL CIRCUITO  
DIESEL

Dotata di adattatori ad innesto rapido

~~120,00€~~ 72,50€

Guarnizioni  
in VITON

1.500CC



**FG 491/200**

**200CC**

**SIRINGA PER OLIO E FLUIDI**  
Fornita con 2 guarnizioni di ricambio

~~30,00€~~ **17,90€**



**FG 491/1500**

**1.500CC**

**SIRINGA PER OLIO**  
Fornita con 2 guarnizioni di ricambio

~~66,00€~~ **39,90€**

Non adatta per carburanti e olii minerali

**FG 491/AD1**

**IMBUTI PER INSERIMENTO LIQUIDO ADBLUE**  
1.1 litri

~~42,00€~~ **24,90€**

**FG 491/AD2**

**IMBUTI PER INSERIMENTO LIQUIDO ADBLUE**  
1.1 litri

~~47,00€~~ **27,90€**



**FG 191/S22**

~~500,00€~~ **299,00€**

**SET UNIVERSALE PER ESTRAZIONE ELETTO-INIETTORI BOSCH, DELPHI, SIEMENS E DENSO**  
- completo di massa battente 4.8KG

**M16**

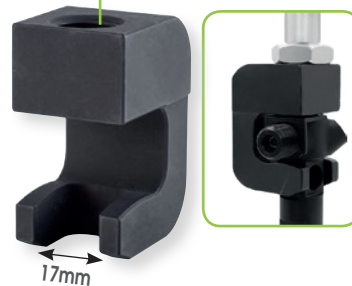

**FG 190/AD1**

**ESTRATTORE A FORCHETTA PER INIETTORI PIEZO ELETTRICI**

~~48,50€~~ **29,50€**

**M16**



**FG 190/AD2**

**ESTRATTORE LATERALE PER ELETTO-INIETTORI BOSCH**

~~32,00€~~ **18,90€**

Per le masse battenti da associare ai codici FG 190/AD e FG 190/AD2 consultare il Catalogo generale a pagina 175

**FG 190/S8**

**KIT ESTRAZIONE INIETTORI BMW N54/MINI N14**



~~130,00€~~ **79,00€**

**FG 190/VW**

**ESTRATTORE A MASSA BATTENTE PER ELETTO-INIETTORI VAG**

~~85,00€~~ **49,90€**

**FG 190/IP**

**UTENSILE PER ESTRAZIONE UGELLO ELETTO-INIETTORI**

~~45,00€~~ **26,90€**





# AUTOMOTIVE



## FG 190/S21

### ASSORTIMENTO 21 UTENSILI E ALESATORI PER PULIZIA SEDI INIETTORI E CANDELETTE

Porta inserto flessibile lungo 1/4"

Porta spazzola con attacco 1/4"

Spazzola corta  $\varnothing$  19mm

Spazzolino lungo  $\varnothing$  7mm

Spazzolino universale

Cappucci per chiusura foro centrale

Asta per cappucci di chiusura

Utensile rimozione rondelle in rame

Utensile con cono di centratura

Coni di centratura

Utensile per fresatura laterale

Adattatore pulizia base iniettore

~~290,00€~~

169,00€



## FG 190/S6B

### SET PER FRESATURA SEDI INIETTORI

CONTENUTO:

- 01 fresa piana 17x19mm
- 01 fresa piana 15x19mm
- 01 fresa piana 17x17mm
- 01 fresa conica 17x21mm
- 01 fresa conica 17x17mm

~~140,00€~~

84,50€

## FG 175/FT3

### CHIAVE REGOLABILE PER GHIERE GALLEGGIANTI SERBATOIO CARBURANTE

per ghiere in plastica FCA (Fiat Freemont, 500L, 500X, Jeep Renegade, ecc)

1/2"  
22mm

145mm

~~70,00€~~

42,00€



## FG 174/SC

### CHIAVE REGOLABILE PER GHIERE GALLEGGIANTI SERBATOIO CARBURANTE $\varnothing$ 88-170mm



~~95,00€~~

57,90€

## FG 174/F1

### CHIAVE REGOLABILE PER GHIERE GALLEGGIANTI SERBATOIO CARBURANTE GRUPPO FCA

150mm

~~65,00€~~

39,50€

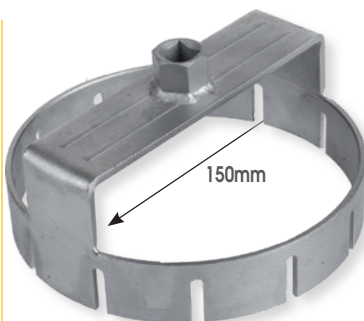

## FG 174/F2

### CHIAVE REGOLABILE PER GHIERE GALLEGGIANTI SERBATOIO CARBURANTE GRUPPO FCA

130mm

~~65,00€~~

39,50€

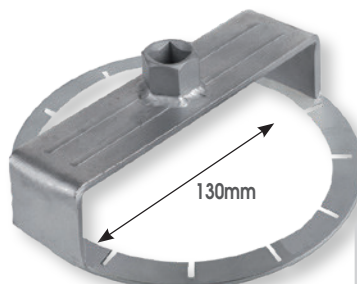



**FG 182/S16**  
**SET ESTRAZIONE**  
**CANDELETTE SPEZZATE**  
 M8, M10, MULTIJET

~~420,00€~~

**249,00€**



**FG 183/S5**  
**SET CHIAVI A BUSSOLA**  
**PER CANDELETTE**  
**PRERISCALDAMENTO**  
**MOTORI DIESEL**

8, 9, 10, 12, 14mm

~~98,00€~~

**58,90€**



3/8"

**FG 181/C14**

**CHIAVE A BUSSOLA SNODATA**  
**PER CANDELE D'ACCENSIONE**  
**MOTORI BMW**

~~25,00€~~

**14,90€**

**FG 181/S130**

**SET RIPRISTINA FILETTI CON ELICOIL**

- M5 - 0.8
- M6 - 1.0
- M8 - 1.25
- M10 - 1.5
- M12 - 1.75

~~255,00€~~

**149,00€**



**FG 181/S115**

**SET RIPRISTINA FILETTI CON ELICOIL**

- M6 - 1.0
- M8 - 1.25
- M10 - 1.5
- M12 - 1.75
- M14 - 1.25

~~325,00€~~

**189,00€**

**FG 800/9** **NEW**

**CHIAVE SMONTAGGIO**  
**VALVOLE GPL GRUPPO VAG**

~~130,00€~~

**79,00€**



1/2"



**FG 179/S16**

**SET UTENSILI PER PULEGGE**  
**LIBERE ALTERNATORI**

~~130,00€~~

**79,00€**







## FG 180/S38

### SET CENTRAGGIO FRIZIONI SAC

- 01 piastra a 3 bracci
- 01 piastra a 4 bracci
- 06 centraggi conici
- 09 perni di centraggio

~~600,00€~~ **359,00€**

## FG 180/S17

### SET DIAGNOSI DOPPIE FRIZIONI DMF

~~550,00€~~ **329,00€**

## FG 178/SF

### APPARECCHIO SPURGO LIQUIDO FRENI

- alimentazione 12V con cavi batteria
- dotato di vano posteriore porta oggetti e contenitore di recupero olio
- 2 tappi universali in dotazione

~~1.450,00€~~ **769,00€**

### TAPPI IN DOTAZIONE



42mm

44,45,46mm

### TAPPI SPECIFICI PER MOTORI FORD (NON IN DOTAZIONE DI BASE)



## FG 178SF/AD13

Fiesta 2011-2016

~~50,00€~~ **29,90€**



## FG 178SF/AD14

Mondeo dal 2014  
Fiesta dal 2016  
Mazda CX3/CX5

~~50,00€~~ **29,90€**



Pressione regolabile fino a 2 Bar

Capacità serbatoio 5L

Scocca in acciaio Inox

Dotato di sensore fine liquido

## FG 178/S6 **NEW**

### KIT TAPPI PER VEICOLI ASIATICI

~~300,00€~~ **179,00€**

- TOYOTA
- HYUNDAI
- NISSAN
- MITSUBISHI
- MAZDA
- SUBARU
- HONDA
- SUZUKI

CE

**FG 199/PF**

**SET ARRETRATORE PNEUMATICO PER PISTONCINI FRENI A DISCO**

Per destrorsi e sinistrorsi

~~180,00€~~ **109,00€**



**FG 198/S11**

**KIT SMONTAGGIO BULLONI PINZE FRENO**

BMW, Ford, VAG, Mercedes

~~120,00€~~ **72,90€**



**FG 198/B9**

**CHIAVE A BUSSOLA PER BULLONI PINZE FRENO - M9**

~~15,00€~~ **8,90€**



1/2"

**FG 627/S3**

**CHIAVI A BUSSOLA PER CERCHI IN LEGA LEGGERA**

17, 19, 21mm

~~75,00€~~ **45,00€**



DOTATE DI ANELLO MAGNETICO DI TENUTA

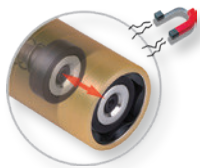

**FG 125/B400**

**LEVA CON ESTREMITÀ A PUNTA E PIATTA CURVA**

~~21,00€~~ **13,50€**



**FG 126/P500**

**LEVA PER PNEUMATICI CON PROTEZIONE ABS**

~~40,00€~~ **24,50€**



**FG 164/S3 NEW**

**KIT RIMOZIONE DADI ANTI FURTO CON COLLARE - BMW**

~~150,00€~~ **89,00€**

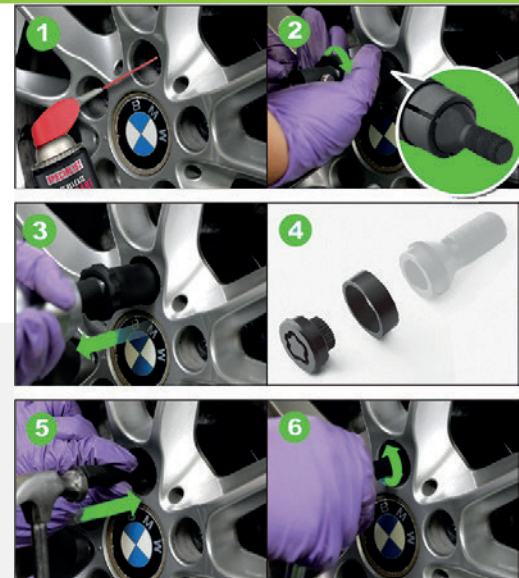



38mm



**FG 169/A44** **NEW**

**CHIAVE A BUSSOLA PER SNODI SFERICI PSA**

~~50,00€~~ **29,90€**

**FG 165/BS...**

**UTENSILE MONTAGGIO E SMONTAGGIO BRACCETTI STERZO**



CODICE	Ø/MM	Ø MM ESTERNO	●/MM	L/MM	€/LISTINO	€/PROMO
FG 169/BS	35 - 45	89	1/2" o 27mm	400	<del>102,00-</del>	<b>61,50</b>
FG 169/BS1	28 - 35	73	1/2" o 27mm	400	<del>96,00-</del>	<b>57,90</b>
FG 169/BS3	35 - 45	89	1/2" o 27mm	190	<del>96,00-</del>	<b>57,90</b>

**FG 166/S28**

**KIT PER SMONTAGGIO E MONTAGGIO CUSCINETTI RUOTA**

- smontaggio Ø 34-45mm
- montaggio Ø 60-84mm

~~380,00€~~ **229,00€**



**FG 166/S7**

**KIT PER ESTRAZIONE GHIERE CUSCINETTI**

- Pinze: Ø 40-45mm, 45-51mm, 50-55mm, 55-61mm
- Chiavi serraggio ghiera: Ø 82.7mm, 58.9mm

~~520,00€~~ **309,00€**



**FG 165/S26**

~~570,00€~~ **349,00€**

**SET UTENSILI SPECIALI PER SMONTAGGIO E MONTAGGIO SILENT BLOCK**

- bocche per Ø 44-82mm
- 4 barre filettate M10, M12, M14, M16



**FG 165/S7**

~~160,00€~~ **98,00€**

**KIT SMONTAGGIO E MONTAGGIO SILENT BLOCK FIAT PANDA 4X4 E PANDA METANO**



SCocca ANTERIORE IN ACCIAIO RESISTENTE AGLI URTI

1/2"

COPPIA MASSIMA



LED DI PUNTAMENTO

IMPUGNATURA BI-MATERIAL PER UN MAGGIOR GRIP

AGGANCIO RINFORZATO

SISTEMA DI SGANCIO RAPIDO

BATTERIA AL LITIO 5.0 AMPERE E 18 VOLT

Modalità L:  
-900RPM  
-200 Nm

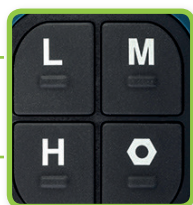

Modalità M:  
-1.200RPM  
-400 Nm

Modalità H:  
-1.900RPM  
- 650 Nm

Modalità svitamento soft:  
permette di applicare una velocità controllata finché il bullone risulta ancora bloccato

**18V - 5.0A  
BRUSHLESS  
MOTOR**

FG 166/S4

AVVITATORE FORNITO IN VALIGETTA DI ABS CON 1 BATTERIA AL LITIO

~~800,00€~~

**349,00€**



FG 166/S4B

AVVITATORE FORNITO IN VALIGETTA DI ABS CON 2 BATTERIE AL LITIO

~~950,00€~~

**399,00€**



**+ IN OMAGGIO**

CHIAVI A BUSSOLA RINFORZATE PER CERCHI IN LEGA LEGGERA





# AUTOMOTIVE

**FG 94/MS**

**SUPPORTO MAGNETICO  
PORTA UTENSILI**

~~30,00€~~

**14,90€**



PVC ANTI-GRAFFIO



IDEALE PER PICCOLI AVVITATORI  
E PISTOLE DI VERNICIATURA



**FG 94/MI**

**SUPPORTO MAGNETICO  
PORTA UTENSILI**

DIMENSIONI: 120x94x400mm

~~45,00€~~

**21,90€**



IDEALE PER CHIAVI A BUSSOLA  
AVVITATORI PNEUMATICI E  
CHIAVE DINAMOMETRICA

**KG  
9**

**PORTATA  
MASSIMA**



**FG 172/PA**

**PINZA PER SERRAGGIO E  
TAGLIO FASCETTE A NASTRO  
IN ACCIAIO INOX**

~~54,00€~~

**32,90€**



INDICATA ANCHE  
PER FASCETTE PANDUIT

**FG 172/TG**

**PINZA RIMOZIONE TUBI  
ACQUA E CARBURANTE**

~~46,50€~~

**27,90€**



**FG 172/AS2**

**PINZA PER ANELLI STRINGITUBO  
CON PROLUNGA INTERCAMBIABILE**

-Apertura: 3-52mm

~~95,00€~~

**57,50€**



**PROLUNGHE SINGOLE**

CODICE	APERTURA	LISTINO	€/PROMO
FG 172/AS2-A	3-52MM	23,00	13,90
FG 172/AS2-B	0-75MM	46,00	27,90
FG 172/AS2-C	0-24MM	26,50	15,90
FG 172/AS2-D	PER CONNETTORI CARBURANTE	29,50	17,90

**FG 172/CL**

**PINZA PER FASCETTE  
A SCATTO CLIC**

~~44,00€~~

**26,90€**



**FG 172/TC**

**PINZA PER RIMOZIONE  
PIOLI CATENE**

~~50,00€~~

**29,90€**



**FG SERVICE 106**

**KIT PROTEZIONE VEICOLI**

~~155,00€~~

**89,00€**

**50** COPRISIEDILI IN POLIETILENE DA 20 MICRON  
**50** TAPPETINI 45X35CM  
 OLTRE **500 METRI** DI FILM COPRI-VOLANTE  
**2** MANOPOLE PER BOBINA COPRI-VOLANTE



**FG 99**

**NEW**

**AVVIATORE 12 V - 2.000A**

~~500,00€~~

**259,00€**



**FG 99/B**

**AVVIATORE 12 V - 2.500A**

~~620,00€~~

**329,00€**

**CE**



**CARATTERISTICHE TECNICHE:**

- Batteria ermetica al piombo (AGM)
- Alimentazione: 220V e accendisigari 12V



# AUTOMOTIVE



**FG 186P/S5**

SET 5 LEVE IN NYLON  
RIMOZIONE PIOLI

~~28,00€~~ **16,90€**



**FG 186/S5**

SET 5 LEVE CON LAMA  
IN ACCIAIO INOX

~~82,00€~~ **49,00€**



**FG 186/S3**

SET 3 LEVERINI IN  
MATERIALE PLASTICO

~~9,00€~~ **5,50€**



**FG 186/S3B**

SET 3 UNCINI IN  
MATERIALE PLASTICO

~~10,50€~~ **6,40€**



**FG 186/S11**

SET 11 UTENSILI IN NYLON  
PER CARROZZERIA

~~105,00€~~ **65,00€**



**FG 130/S10**

SET 10 UTENSILI  
PER CARROZZERIA

~~490,00€~~ **289,00€**



**FG 131/TR**



**FG 131/TB**



**FG 131/TC**



**FG 131/TV**



**FG 131/SC**



**FG 130/TQ**



**FG 130/TPP**



**FG 136/30**



**FG 131/PL12**



**FG 131/SCZ**



**FG 187/S7**

**SET 7 UTENSILI PER CRISTALLI AUTO**

~~185,00€~~ **109,00€**

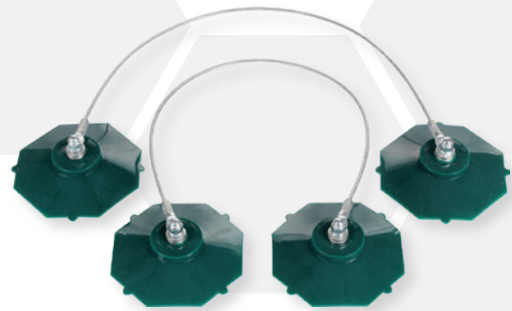

**FG 187/K10**

**KIT 4 MINI-VENTOSE PER CRISTALLI AUTO** - capacità 10Kg

~~21,00€~~ **12,90€**

**FG 186/AS**

**GIRAVITE ANGOLARE**

~~36,00€~~ **19,90€**



**FG 187/K130**

**VENTOSA SINGOLA MULTIFUNZIONE**

- Capacità: 130Kg
- Diametro: 254mm
- Adatta per parabrezza autobus e mezzi pesanti
- Fornita in box di ABS

~~252,00€~~ **149,00€**



**FG 187/PN**

**TIRABOLLI PNEUMATICO, COMPLETO DI 3 VENTOSE**

~~225,00€~~ **138,00€**







# AUTOMOTIVE

## ACCESSORI DI BASE IN DOTAZIONE



**FG 215**

### TESTER PROVA COMPRESSIONE DIGITALE

#### CARATTERISTICHE TECNICHE:

- grado di precisione: 1%FS
- software in 8 lingue (IT, EN, DE, FR, ES, PT, GR, PL)
- display touch screen LCD retroilluminato a colori, 4.3"

**MADE IN ITALY**

**FG 215/S40**

### TESTER PROVA COMPRESSIONE DIGITALE, COMPLETO DI FINTI INIETTORI E FINTE CANDELETTE PER SISTEMI DIESEL

~~800,00€~~

**479,00€**

~~1.350,00€~~

**799,00€**

**FG 215 È UN TESTER DIGITALE IN GRADO DI MISURARE LA COMPRESSIONE DEI SISTEMI AD ALIMENTAZIONE DIESEL E BENZINA. IDEATO, INGEGNERIZZATO E PRODOTTO INTERAMENTE IN ITALIA, RAPPRESENTA UNA VERA RIVOLUZIONE TECNOLOGICA!**

### FUNZIONE PROVA ALTERNATORE



### SCHEMATTA PRINCIPALE FG 215

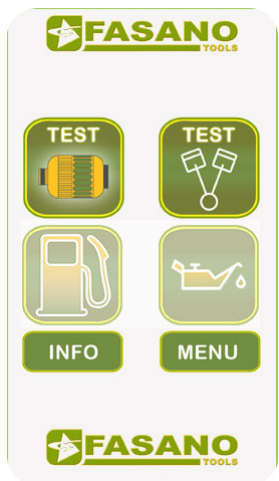

### FUNZIONE PROVA COMPRESIONE E TENSIONE BATTERA

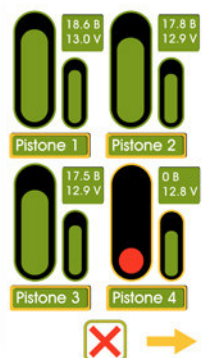

FASANO TOOLS  
Via G. VITTORIO  
10090 SASSO  
P.I. 044  
Tel. 0432/200077 Email

PROVE DI PRESSIONE SU CILINDRI

Dati Cliente  
Nome: FLORIANO Cognome: CAMPA Luogo e Data di Nascita:

Dati Autoveicolo  
Marca: Modello: Anno: Targa:

Dati Misurazioni

Misure Eseguite - I valori minimi sono evidenziati in rosso

N. CIL.	C1	C2	C3	C4
P.(BAR)	14.0	15.0	15.0	15.0
Tens.(V)	10.0	11.0	11.0	11.0

Valori  
Cilindri  
■ Pressione (Bar) ■ Tensione (Volt)

Data: 05/12/2014 11:54:50 Firma e Timbro

**POSSIBILITÀ DI MEMORIZZARE E SCARICARE LE PROVE SU PC, PERSONALIZZANDO LA SCHEDA DATI CON TUTTE LE INFORMAZIONI DEL CLIENTE DELLA PROPRIA AUTOFFICINA (INCLUSO IL LOGO)**

MADE IN ITALY

FG 219/S



**TESTER MULTI-FUNZIONE  
PER PROVA COMPRESSIONE  
E PROVA PRESSIONE CARBURANTI**

**CARATTERISTICHE TECNICHE:**

- grado di precisione: 1%FS
- software in 8 lingue (IT, EN, DE, FR, ES, PT, GR, PL)
- display touch screen LCD retroilluminato a colori, 4,3"
- 2 sensori (0-80Bar e 0.2500Bar)

~~2.700,00€~~

**1.699,00€**



**POSSIBILITÀ DI MEMORIZZARE  
E SCARICARE LE PROVE SU PC,  
PERSONALIZZANDO LA SCHEDA  
DATI CON TUTTE LE INFORMAZIONI  
DEL CLIENTE DELLA PROPRIA  
AUTOFFICINA (INCLUSO IL LOGO)**

**SCHEMATA PRINCIPALE  
FG 219**

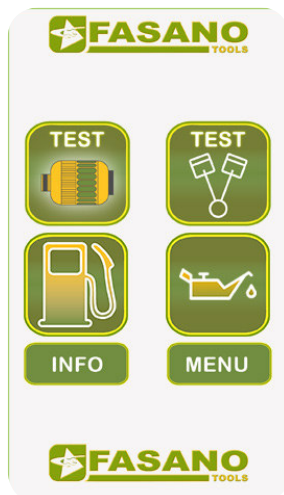

**PROVA ALTERNATORE  
PROVA COMPRESSIONE  
PROVA TENSIONE BATTERIA**



**PROVA PRESSIONE CARBURANTE  
(ALTA E BASSA)**



**PROVA OLIO MOTORE**

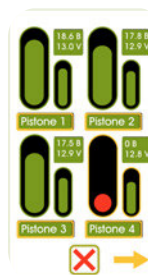



### CARRELLI E BANCHI DA LAVORO

LA GAMMA DI CARRELLI PORTA UTENSILI FASANO TOOLS È COMPOSTA DA 11 MODELLI DIVERSI, CHE A LORO VOLTA SI COMPONGONO DI DIVERSE VARIANTI DI COLORE, DI NUMERO DI CASSETTI E TIPOLOGIA DI TOP. PER OGNI ESIGENZA QUOTIDIANA L'UTILIZZATORE PUÒ TROVARE LA SOLUZIONE PIÙ ADEGUATA ALLE PROPRIE ESIGENZE, CON UN OCCHIO PARTICOLARE ALL'IMMAGINE E ALLA CURA DEI PARTICOLARI.

**FG 101** **NEW**

## CARRELLO PORTA UTENSILI MOD. FG 101

### CARATTERISTICHE TECNICHE:

- Guide telescopiche con sistema di aggancio automatico
- 4 ruote in gomma vulcanizzata Ø125mm (2 fisse e 2 girevoli - 1 con freno)
- maniglione laterale in acciaio
- chiusura centralizzata
- cassetti dotati di tappetino interno in gomma



**SISTEMA DI APERTURA A BAIONETTA**



**MANIGLIONE IN ACCIAIO**



**TOP IN GOMMA**

CODICE	CASSETTI	€/LISTINO	€/PROMO
FG 101V/5G	5 CASSETTI	600,00	329,00
FG 101V/6G	6 CASSETTI	625,00	349,00
FG 101V/7G	7 CASSETTI	660,00	369,00

**KG 500** PORTATA STATICA



**FG 102**

## CARRELLO PORTA UTENSILI MOD. FG 102

### CARATTERISTICHE TECNICHE:

- Guide telescopiche con sistema di aggancio automatico
- 4 ruote in gomma vulcanizzata Ø125mm
- maniglione laterale in acciaio
- chiusura centralizzata
- cassetti dotati di tappetino interno in gomma

**MADE IN ITALY**



**4 RUOTE Ø125 (2 GIREVOLI-2 FISSE)**



**MANIGLIONE IN ACCIAIO**



**TOP IN GOMMA**



**KG 800** PORTATA STATICA

CODICE	Cassetti	€/Listino	€/PROMO
FG 102V/5G	5 CASSETTI	850,00	429,00
FG 102V/6G	6 CASSETTI	900,00	469,00
FG 102V/7G	7 CASSETTI	950,00	499,00
FG 102V/8G	8 CASSETTI	1.000,00	519,00

# FG 102



# CARRELLI E BANCHI DA LAVORO



## FG 100

**FG 100**

### CARRELLO PORTA UTENSILI MOD. FG 100

#### CARATTERISTICHE TECNICHE:

- Guide telescopiche con sistema di aggancio automatico
- 4 ruote in gomma vulcanizzata Ø125mm
- ripiano superiore in ABS con maniglione integrato
- chiusura laterale centralizzata
- porta flaconi laterali di serie

**MADE IN ITALY**



SISTEMA DI CHIUSURA LATERALE



RIPIANO SUPERIORE IN ABS



CASSETTO CON APERTURA COMPLETA



**KG 800** PORTATA STATICA

CODICE			CASSETTI	€/LISTINO	€/PROMO
FG 100V/5T	FG 100B/5T	FG 100R/5T	5 CASSETTI	1.150,00	489,00
FG 100V/6T	FG 100B/6T	FG 100R/6T	6 CASSETTI	1.200,00	509,00
FG 100V/7T	FG 100B/7T	FG 100R/7T	7 CASSETTI	1.250,00	529,00



## FG 150

**FG 150**

### CARRELLO PORTA UTENSILI MOD. FG 150

#### CARATTERISTICHE TECNICHE:

- Guide telescopiche con sistema di aggancio automatico
- 4 ruote in gomma vulcanizzata Ø125mm
- maniglione laterale in acciaio
- chiusura centralizzata
- cassetti dotati di tappetino interno in gomma

**MADE IN ITALY**



4 RUOTE Ø125 (2 GIREVOLI-2 FISSE)



TAPPETINO INTERNO



MANIGLIONE IN ACCIAIO INOX



**KG 800** PORTATA STATICA

CODICE			CASSETTI	€/LISTINO	€/PROMO
FG 150R/5G	FG 150D/5G	FG 150D/5G	5 CASSETTI	930,00	519,00
FG 150R/6G	FG 150D/6G	FG 150D/6G	6 CASSETTI	965,00	539,00
FG 150R/7G	FG 150D/7G	FG 150D/7G	7 CASSETTI	1.000,00	559,00

## FG 104

### CARRELLO PORTA UTENSILI MOD. FG 104

#### CARATTERISTICHE TECNICHE:

- Guide telescopiche con sistema di aggancio automatico
- 4 ruote in gomma vulcanizzata Ø125mm
- maniglione laterale in acciaio
- chiusura centralizzata
- cassetti dotati di tappetino interno in gomma

**MADE IN ITALY**

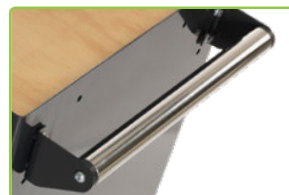

MANIGLIONE IN ACCIAIO INOX



CHIUSURA CENTRALIZZATA



**KG 1000** PORTATA STATICA

**FG 104**  
MAXI

CODICE				CASSETTI	€/LISTINO	€/PROMO
FG 104V/6G	FG 104D/6G	FG 104B/6G	FG 104R/6G	6 CASSETTI	<del>1.100,00</del>	559,00
FG 104V/7G	FG 104D/7G	FG 104B/7G	FG 104R/7G	7 CASSETTI	<del>1.150,00</del>	599,00

## FG 105

### CARRELLO PORTA UTENSILI MOD. FG 105

#### CARATTERISTICHE TECNICHE:

- Guide telescopiche con sistema di aggancio automatico
- 4 ruote in gomma vulcanizzata Ø125mm
- maniglione laterale in acciaio
- chiusura centralizzata
- cassetti dotati di tappetino interno in gomma

**MADE IN ITALY**



RIPIANI INTERNI REGOLABILI



ANTINA APRIBILE A 90°, DOTATA DI SERRATURA



**FG 105**  
XL

CODICE				CASSETTI	€/LISTINO	€/PROMO
FG 105V/5G	FG 105B/5G	FG 105R/5G	FG 105D/6G	5 CASSETTI	<del>1.100,00</del>	599,00
FG 105V/6G	FG 105B/6G	FG 105R/6G	FG 105D/6G	6 CASSETTI	<del>1.175,00</del>	649,00
FG 105V/7G	FG 105B/7G	FG 105R/7G	FG 105D/7G	7 CASSETTI	<del>1.225,00</del>	679,00



# CARRELLI E BANCHI DA LAVORO

## FG 160

### CARRELLO PORTA UTENSILI MOD. FG 160

#### CARATTERISTICHE TECNICHE:

- Guide telescopiche con sistema di aggancio automatico
- 4 ruote in gomma vulcanizzata Ø160mm
- maniglione laterale in acciaio
- chiusura centralizzata
- cassetti dotati di tappetino interno in gomma



- Antina apribile a 90°, dotata di serratura con chiave
- 2 ripiani interni amovibili



- 7 cassetti porta minuteria
- Profondità: 580x235mm

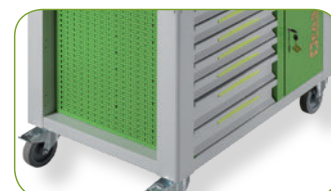

- Larga griglia laterale porta utensili
- Dimensioni: 665x595mm



**KG 2.400** PORTATA STATICA

CODICE				CASSETTI	€/LISTINO	€/PROMO
FG 160V/14L	FG 160B/14L	FG 160R/14L	FG 160D/14L	14 CASSETTI	<del>3.000,00</del>	<b>1.499,00</b>

# JUMBO

**MADE IN ITALY**

## FG 102/PL

**PORTA LATTINE**  
PER FG 102, FG 103,  
FG 104, FG 105, FG 109

~~52,50€~~ **31,50€**



## FG 102/PR

**PORTA ROTOLO**  
PER FG 102, FG 103,  
FG 104, FG 105, FG 109

~~56,00€~~ **33,90€**



## FG 94/R

**PORTA MINUTERIE MAGNETICO**

Dimensione: 165x245mm

~~18,00€~~ **10,90€**



## FG 94/T

**PORTA MINUTERIE MAGNETICO**

Ø 150mm

~~15,00€~~ **8,90€**



**FG 101V/AS190**

**CARRELLO PORTA UTENSILI FG 101  
A 7 CASSETTI CON ASSORTIMENTO  
190 UTENSILI IN MODULI RIGIDI**

~~1,841,00€~~

**799,00€**

**KG 500** PORTATA  
STATICA

## 1°CASSETTO

- FG 102/03G: Modulo 14 chiavi combinate 6 - 19mm
- FG 102/21B: Modulo chiavi a bussola esagonali 1/2" 8-32mm+accessori
- FG 102/17E: Modulo 65 utensili da 1/4"



## 3°CASSETTO

- FG 102/48G: Modulo 52 inserti con attacco 10mm
- FG 102/65B: Modulo pinza autobloccante e pinza a cerniera
- FG 102/23C: Modulo 14 utensili rinforzati da 1/2"



## 2°CASSETTO

- FG 102/39D: Modulo 3 pinze
- FG 102/VA1: Modulo porta minuterie
- FG 102/45D: Modulo 6 giraviti a taglio e a croce



## 4°CASSETTO

- FG 102/10C: Modulo 8 chiavi a T snodate esagonali 7-19mm

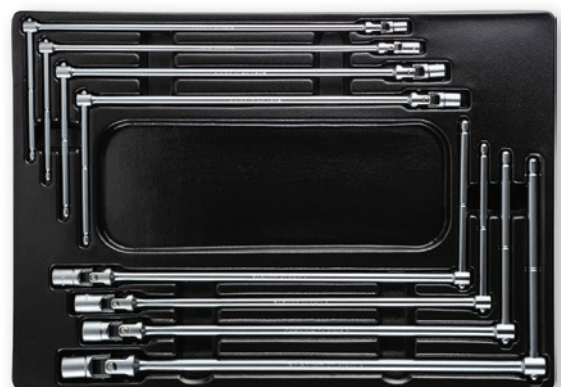





# CARRELLI E BANCHI DA LAVORO



**FG 102V/AS149**

**CARRELLO PORTA UTENSILI FG 102 A 7 CASSETTI CON ASSORTIMENTO 149 UTENSILI IN MODULI RIGIDI**

~~2.076,50€~~

**899,00€**



**KG 800** PORTATA STATICA

CODICE				€/LISTINO	€/PROMO
FG 102V/AS149	FG 102B/AS149	FG 102R/AS149	FG 102D/AS149	2.076,50-	899,00

## 1°CASSETTO

- **FG 102/03G:** Modulo 14 chiavi combinate 6 - 19mm
- **FG 102/VA1:** Modulo porta minuterie
- **FG 102/03L:** Modulo rigido 6 chiavi combinate



## 3°CASSETTO

- **FG 102/45E:** Modulo 8 giraviti ad intaglio e a croce Phillips
- **FG 102/45I:** Modulo 6 giraviti con impronta Torx
- **FG 102/48D:** Modulo 40 inserti da 1/4" + porta inserti



## 2°CASSETTO

- **FG 102/17:** Modulo chiavi a bussola da 1/4" 4-14mm + accessori
- **FG 102/19:** Modulo 18 utensili da 3/8"
- **FG 102/21B:** Modulo 25 utensili da 1/2"



## 4°CASSETTO

- **FG 102/39D:** Modulo 3 pinze con manici in pvc
- **FG 102/42C:** Modulo 4 pinze per anelli elastici 19-60mm
- **FG 102/65B:** Modulo pinza autobloccante e pinza regolabile a cerniera aperta





**FG 102V/AS158**

**CARRELLO PORTA UTENSILI FG 102 A 6 CASSETTI CON ASSORTIMENTO 158 UTENSILI IN MODULI RIGIDI**

~~2.287,00€~~ **949,00€**



**KG 800** PORTATA STATICA

CODICE				€/LISTINO	€/PROMO
FG 102V/AS158	FG 102B/AS158	FG 102R/AS158	FG 102D/AS158	2.287,00	949,00

### 1°CASSETTO

- **FG 102/03G:** Modulo 14 chiavi combinate 6 - 19mm
- **FG 102/21B:** Modulo chiavi a bussola esagonali 1/2" 8-32mm + accessori
- **FG 102/17:** Modulo chiavi a bussola da 1/4" 4-14mm + accessori



### 3°CASSETTO

- **FG 102/45F:** Modulo 6 giraviti a croce phillips
- **FG 102/45G:** Modulo 7 giraviti ad intaglio
- **FG 102/45I:** Modulo 6 giraviti TORX



### 2°CASSETTO

- **FG 102/21TX:** Modulo 44 utensili TORX
- **FG 102/21H:** Modulo rigido inserti a bussola 1/2" esagonali e XZN
- **FG 102/39D:** Modulo 3 pinze con manici in pvc



### 4°CASSETTO

- **FG 102/10C:** Modulo 8 chiavi a T snodate esagonali 7-19mm





# CARRELLI E BANCHI DA LAVORO



**FG 100V/AS193**

**CARRELLO PORTA UTENSILI FG 100  
A 7 CASSETTI CON ASSORTIMENTO  
193 UTENSILI IN MODULI RIGIDI**

~~2,501,00€~~ **999,00€**



**KG  
800** **PORTATA  
STATICA**

CODICE			€/LISTINO	€/PROMO
FG 100V/AS193	FG 100B/AS193	FG 100R/AS193	2.501,00	999,00

## 1°CASSETTO

- **FG 102/03G:** Modulo 14 chiavi combinate 6 - 19mm
- **FG 102/03L:** Modulo rigido 6 chiavi combinate
- **FG 102/21B:** Modulo chiavi a bussola esagonali 1/2" 8-32mm + accessori



## 3°CASSETTO

- **FG 102/39D:** Modulo 3 pinze
- **FG 102/42C:** Modulo 4 pinze per anelli elastici 19-60mm
- **FG 102/45D:** Modulo 6 giraviti a taglio e a croce



## 2°CASSETTO

- **FG 102/17E:** Modulo 65 utensili da 1/4"
- **FG 102/48G:** Modulo inserti corti e lunghi con attacco 10mm
- **FG 102/45I:** Modulo 6 giraviti con impronta Torx



## 4°CASSETTO

- **FG 102/56C:** Modulo utensili da percussione
- **FG 102/65B:** Modulo pinza autobloccante e inza regolabile a cerniera aperta
- **FG 102/62B:** Modulo 5 lime a taglio mezzodolce





**FG 100V/AS229**

**CARRELLO PORTA UTENSILI FG 100 A 7 CASSETTI CON ASSORTIMENTO 229 UTENSILI IN MODULI RIGIDI**

~~2,650,00€~~ **999,00€**



**KG 800** **PORTATA STATICA**

CODICE			€/LISTINO	€/PROMO
FG 100V/AS229	FG 100B/AS229	FG 100R/AS229	2.650,00	999,00

### 1°CASSETTO

- **FG 102/03G:** Modulo 14 chiavi combinate 6 - 19mm
- **FG 102/03L:** Modulo rigido 6 chiavi combinate
- **FG 102/21B:** Modulo chiavi a bussola esagonali 1/2" 8-32mm + accessori



### 3°CASSETTO

- **FG 102/39D:** Modulo 3 pinze
- **FG 102/45D:** Modulo 6 giraviti a taglio e a croce
- **FG 102/45I:** Modulo 6 giraviti con impronta Torx



### 2°CASSETTO

- **FG 102/17E:** Modulo 65 utensili da 1/4"
- **FG 102/48G:** Modulo inserti corti e lunghi con attacco 10mm
- **FG 102/21TX:** Modulo 44 utensili Torx



### 4°CASSETTO

- **FG 102/10C:** Modulo 8 chiavi a T snodate esagonali 7-19mm





# CARRELLI E BANCHI DA LAVORO



FG 102/03G

~~118,00€~~ 69,90€

**MODULO RIGIDO 14 CHIAVI COMBinate**

6, 7, 8, 9, 10, 11, 12, 13, 14, 15, 16, 17, 18, 19 mm



FG 102/03H

**MODULO RIGIDO 18 CHIAVI COMBinate**

6, 7, 8, 10, 11, 12, 13, 14, 16, 17, 18, 19, 21, 22, 24, 27, 30, 32 mm

~~220,00€~~ 129,00€



FG 102/03L

~~122,00€~~ 72,90€

**MODULO RIGIDO 6 CHIAVI COMBinate**

21, 22, 24, 27, 30, 32 mm



FG 102/03E

**MODULO RIGIDO 8 CHIAVI A DOPPIA FORCHETTA**

6x7-20x22 mm + 139C/FS

~~68,50€~~ 39,90€



FG 102/03F

**MODULO RIGIDO 5 CHIAVI A DOPPIA FORCHETTA**

21x23, 24x26, 25x28, 27x29, 30x32 mm

~~75,00€~~ 45,00€

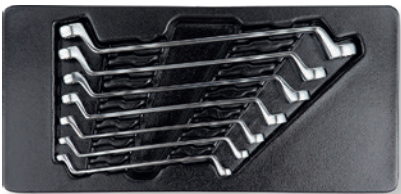

FG 102/07C

~~77,50€~~ 45,90€

**MODULO 7 CHIAVI DOPPIE POLIGONALI**

6x7, 8x9, 10x11, 12x13, 14x15, 16x17, 18x19mm



FG 102/07D

~~112,50€~~ 66,90€

**MODULO 5 CHIAVI DOPPIE POLIGONALI**

20x22, 21x23, 24x27, 25x28, 30x32mm



FG 102/08C

~~190,00€~~ 115,00€

**MODULO 8 CHIAVI COMBinate A CRICCO REVERSIBILE**

8, 10, 11, 12, 13, 14, 15, 16, 17, 18, 19mm



FG 102/10C

**MODULO 8 CHIAVI A T SNODATE ESAGONALI**

7, 8, 10, 11, 13, 14, 17, 19 mm

~~245,00€~~ 149,00€



FG 102/13C

~~145,00€~~ 85,00€

**MODULO 10 CHIAVI A PIPA ESAGONALI-POLIGONALI**

6,7,8,10,11,12,13,14, 17,19mm



FG 102/17

**MODULO 18 UTENSILI DA 1/4"**

4-14mm

~~98,00€~~ 59,90€



FG 102/17E

**MODULO 65 UTENSILI DA 1/4"**

~~240,00€~~ 145,00€



**FG 102/19**

**MODULO 18 UTENSILI DA 3/8"**  
8-23mm ESAGONALI

~~180,00€~~ **109,00€**



**FG 102/19B**

**MODULO 18 UTENSILI DA 3/8"**  
8-23mm POLIGONALI

~~160,00€~~ **98,00€**



**FG 102/21B**

**MODULO 25 UTENSILI DA 1/2"**  
10-32mm ESAGONALI

~~202,00€~~ **122,50€**



**FG 102/21C**

**MODULO 25 UTENSILI DA 1/2"**  
10-32mm POLIGONALI

~~202,00€~~ **122,50€**



**FG 102/21E**

**MODULO 16 UTENSILI DA 1/2"**  
10-32mm ESAGONALI

~~135,00€~~ **82,50€**

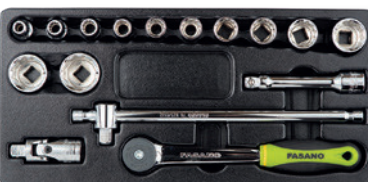

**FG 102/21D**

**MODULO 16 UTENSILI DA 1/2"**  
10-32mm POLIGONALI

~~135,00€~~ **82,50€**



**FG 102/21TX**

**MODULO 44 UTENSILI TORX**

~~210,00€~~ **125,00€**



**FG 102/21H**

**MODULO RIGIDO INSERTI A BUSSOLA 1/2" ESAGONALI E XZN**

~~310,00€~~ **109,00€**

**FG 102/25**

**MODULO 9 UTENSILI DA 3/4"**  
34-50mm ESAGONALI

~~350,00€~~  
**199,00€**



**FG 102/25B**

**MODULO 9 UTENSILI DA 3/4"**  
34-50mm POLIGONALI

~~350,00€~~  
**199,00€**



**FG 102/21R**

**MODULO INSERTI A BUSSOLA RIBE**  
R4-R14, LR4,LR14

~~266,00€~~ **119,00€**



**FG 102/23C**

**MODULO 14 UTENSILI RINFORZATI DA 1/2"**  
10,11,12,13,14,16,17,18,19,21,22,23,24mm + FG 628/PR125

~~105,00€~~ **65,00€**



**FG 102/51H**

**MODULO 7 CHIAVI A T MASCHIO ESAGONALI**  
10,11,12,2, 2.5, 3, 4, 5, 6, 8mm

~~103,50€~~ **62,50€**



**FG 102/39C**

**MODULO 3 PINZE SOFT-RUN**  
FG 59SR/180, FG 61SR/160, FG 63SR/160

~~72,00€~~ **42,90€**



**FG 102/39D**

**MODULO 3 PINZE CON MANICI IN PVC**  
FG 59PV/180, FG 61PV/160, FG 63PV/160

~~62,00€~~ **36,90€**



# CARRELLI E BANCHI DA LAVORO



FG 102/41C

~~85,00€~~

49,90€

MODULO 4 PINZE PER ANELLI ELASTICI

Capacità: 8-25mm



FG 102/42C

~~90,00€~~

54,90€

MODULO 4 PINZE PER ANELLI ELASTICI

Capacità: 19-60mm



FG 102/45D

~~38,00€~~

22,90€

MODULO 6 GIRAVITI AD INTAGLIO E A CROCE PHILLIPS

3x100, 4x125, 5.5x150, 6.5x150, PH1x80, PH2x150



FG 102/45E

~~48,50€~~

29,50€

MODULO 8 GIRAVITI AD INTAGLIO E A CROCE PHILLIPS

3x100, 4x125, 5.5x150, 6.5x150, 6.5x38 PH1x80, PH2x150, PH2x38



FG 102/45U

MODULO 12 GIRAVITI AD INTAGLIO E A CROCE PHILLIPS

2.5x60, 3x75, 4x30, 4x100, 5.5x150, 8x150, PH 0x60, PH1x30, PH1x80, PH2x100, PH3x150

~~73,00€~~

43,90€



FG 102/45F

~~45,00€~~

26,90€

MODULO 6 GIRAVITI A CROCE PHILLIPS

PH0x60, PH1x150, PH2x100, PH2x150, PH3x150, PH2x38

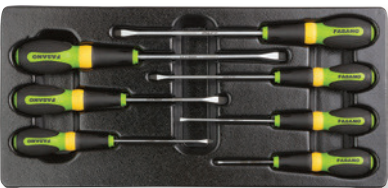

FG 102/45G

~~42,00€~~

24,90€

MODULO 7 GIRAVITI AD INTAGLIO

2.5x60, 3x100, 3.5x100, 4x125, 5.5x150, 5.5x100, 6.5x150



FG 102/45I

~~55,00€~~

32,90€

MODULO 6 GIRAVITI TORX

TX10, TX15, TX20, TX25, TX27, TX30



FG 102/45L

~~57,00€~~

33,90€

MODULO 6 GIRAVITI TORX CON FORO

RTX10, RTX15, RTX20, RTX25, RTX27, RTX30



FG 102/45T

~~57,50€~~

34,50€

MODULO 5 GIRAVITI A BUSSOLA ESAGONALI

FX6, FX7, FX8, FX10, FX13



FG 102/48D

~~88,00€~~

49,90€

MODULO 40 INSERTI DA 1/4"  
+ PORTA INSERTI



FG 102/48G

~~108,00€~~

65,50€

MODULO 52 INSERTI DA 10MM  
+ ADATTATORE PER CRICCHETTO DA 1/2"



FG 102/50F

~~65,00€~~

39,90€

MODULO 6 CHIAVI MASCHIO ESAGONALI  
2, 2.5, 3, 4, 5, 6mm



FG 102/50G

~~65,00€~~

39,90€

MODULO 6 CHIAVI MASCHIO TORX  
TX10, TX15, TX20, TX25, TX27, TX30



FG 102/56C

~~98,00€~~

58,90€

MODULO UTENSILI DA PERCUSSIONE  
FG 132/500, FG 136/40, FG 126/SN1, FG 126/SN3



FG 102/60C

~~35,00€~~

21,00€

MODULO UTENSILI PER MANUTENZIONE  
FG 50/MS, FG 48/L, FG 497/OP1, FG 44/MT5



FG 102/62B

~~68,00€~~

41,50€

MODULO 5 LIME A TAGLIO MEZZODOLCE



FG 102/62C

~~68,00€~~

41,50€

MODULO 5 LIME A TAGLIO BASTARDO



FG 102/65B

~~50,00€~~

29,90€

MODULO PINZA AUTOBLOCCANTE  
E PINZA REGOLABILE A CERNIERA APERTA



FG 102/VA1

~~13,00€~~

7,90€

MODULO PORTA MINUTERIE





# CARRELLI E BANCHI DA LAVORO



**FG 102V/AS161**

**CARRELLO PORTA UTENSILI FG 102  
A 6 CASSETTI CON ASSORTIMENTO  
161 UTENSILI IN MODULI DI GOMMA**

~~2.065,50€~~ **999,00€**



**KG 800** PORTATA  
STATICA

CODICE				€/LISTINO	€/PROMO
FG 102D/AS161	FG 102B/AS161	FG 102R/AS161	FG 102V/AS161	2.065,50-	999,00

## 1°CASSETTO

- **FG 100/03G:** Modulo 14 chiavi combinate 6 - 19mm
- **FG 100/VA1:** Modulo porta minuterie
- **FG 100/07C:** Modulo 7 chiavi doppie poligonali

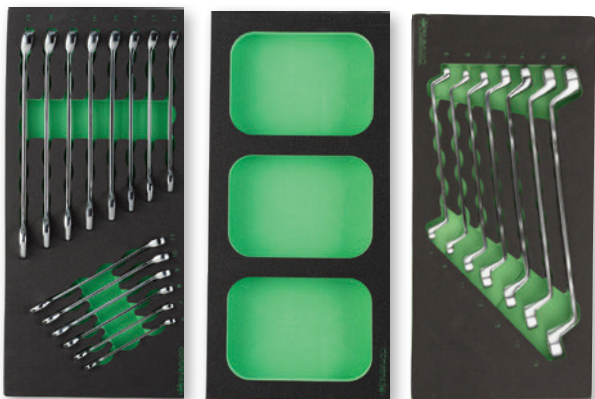

## 2°CASSETTO

- **FG 100/17:** Modulo 11 chiavi a bussola da 1/4" esagonali + accessori
- **FG 100/19:** Modulo chiavi a bussola esagonali
- **FG 100/21B:** Modulo 25 utensili da 1/2"

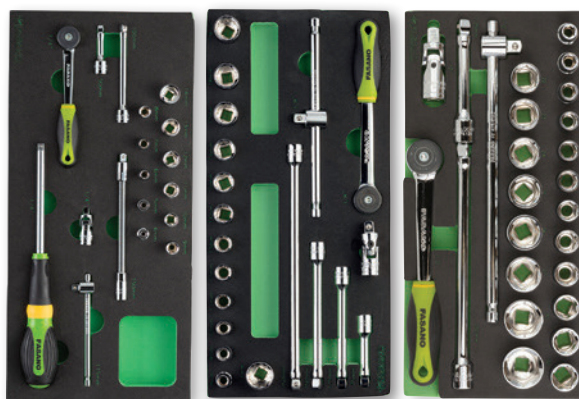

## 3°CASSETTO

- **FG 100/39C:** Modulo 3 pinze assortite
- **FG 100/VA1:** Modulo porta minuterie
- **FG 100/48G:** Modulo 52 inserti da 10mm



## 4°CASSETTO

- **FG 100/45F:** Modulo 6 giraviti a croce Phillips
- **FG 100/45G:** Modulo 7 giraviti a taglio
- **FG 100/45I:** Modulo 6 giraviti TORX

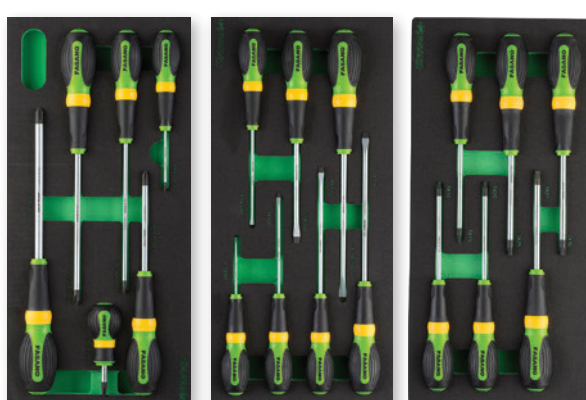



**FG 100V/AS226**

**CARRELLO PORTA UTENSILI FG 100  
A 7 CASSETTI CON ASSORTIMENTO  
226 UTENSILI IN MODULI DI GOMMA**

~~2.706,00€~~ **1.099,00€**



**KG 800** PORTATA  
STATICA

CODICE	€/LISTINO	€/PROMO
FG 100V/AS226	2.706,80	1.099,00
FG 100B/AS226		
FG 100R/AS226		

### 1°CASSETTO

- FG 100/03G: Modulo 14 chiavi combinate 6 - 19mm
- FG 100/17E: Modulo 11 chiavi a bussola da 1/4" esagonali + accessori
- FG 100/21B: Modulo chiavi a bussola esagonali 1/2" 8-32mm + acc.



### 2°CASSETTO

- FG 100/39C: Modulo 3 pinze assortite
- FG 100/VA1: Modulo porta minuterie
- FG 100/21TX: Modulo 44 utensili TORX



### 3°CASSETTO

- FG 100/45I: Modulo 6 giraviti con impronta Torx
- FG 100/45E: Modulo 8 giraviti a taglio e croce Phillips
- FG 100/48G: Modulo inserti cortie e lunghi con attacco 10mm



### 4°CASSETTO

- FG 100/10C: Modulo 8 chiavi a T snodate 7-19mm

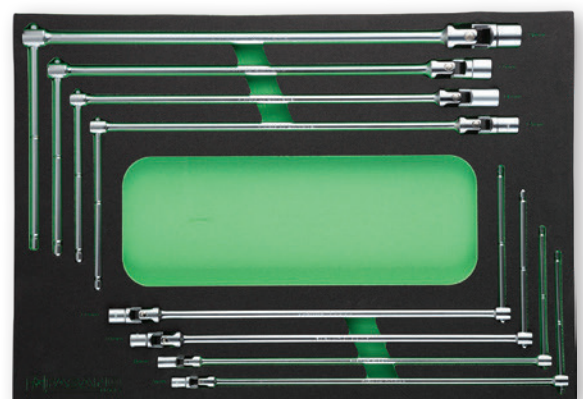



# CARRELLI E BANCHI DA LAVORO



**KG 800** PORTATA STATICA

CODICE	€/LISTINO	€/PROMO
FG 150R/AS173	2.747,00	1.199,00
FG 150D/AS173	2.747,00	1.199,00

**FG 150R/AS173**

**CARRELLO PORTA UTENSILI  
A 7 CASSETTI CON ASSORTIMENTO  
173 UTENSILI IN MODULI DI GOMMA**

~~2.747,00€~~ **1.199,00€**

## 1°CASSETTO

- FG 100/03G: Modulo 14 chiavi combinate 6 - 19mm
- FG 100/VA1: Modulo di riempimento con vani porta minuteria
- FG 100/03E: Modulo 8 chiavi a forchetta 6x7-20x22mm + set 9 chiavi maschio esagonali



## 3°CASSETTO

- FG 100/81F: Modulo inserti a bussola da 1/2" esagonali e XZN
- FG 100/42C: Modulo 4 pinze per anelli elastici 19-60mm
- FG 100/65B: Modulo pinze autobloccanti e a cerniera



## 5°CASSETTO

- FG 100/10C: Modulo 8 chiavi a T snodate 7-19mm

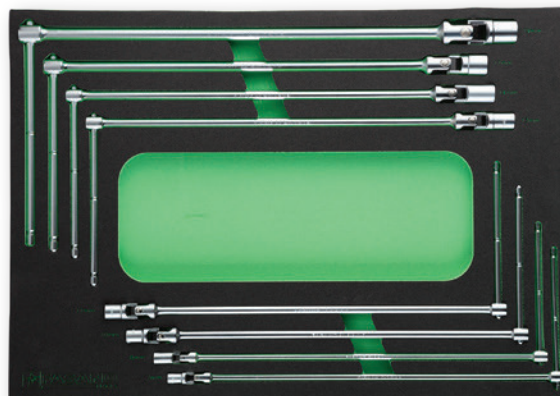

## 2°CASSETTO

- FG 100/17: Modulo 11 chiavi a bussola da 1/4" esagonali + acc.
- FG 100/21TX: Modulo 44 utensili con impronta TORX
- FG 100/21B: Modulo chiavi a bussola esagonali 1/2" 8-32mm + acc.



## 4°CASSETTO

- FG 100/39C: Modulo 3 pinze assortite
- FG 100/45D: Modulo 6 giraviti ESTRO a taglio e croce PH
- FG 100/45I: Modulo 6 giraviti con impronta TORX





**KG 800** PORTATA STATICA

CODICE			€/LISTINO	€/PROMO
FG 100V/AS230	FG 100B/AS230	FG 100R/AS230	3.348,00	1.299,00

## FG 100V/AS230

**CARRELLO PORTA UTENSILI FG 100  
7 CASSETTI CON ASSORTIMENTO  
230 UTENSILI IN MODULI IN GOMMA**

~~3.348,00€~~ **1.299,00€**

### 1° CASSETTO

- FG 100/03G: Modulo 14 chiavi combinate 6 - 19mm
- FG 100/VA1: Modulo di riempimento con vani porta minuteria
- FG 100/03L: Modulo 6 chiavi combinate



### 2° CASSETTO

- FG 100/17E: Modulo 65 utensili da 1/4"
- FG 100/21TX: Modulo 44 utensili con impronta Torx
- FG 100/21B: Modulo chiavi a bussola esagonali 1/2" 8-32mm + acc.



### 4° CASSETTO

- FG 100/39C: Modulo 3 pinze assortite
- FG 100/45E: Modulo 8 giraviti ad intaglio e a croce phillips
- FG 100/45I: Modulo 6 giraviti con impronta TORX



### 3° CASSETTO

- FG 100/81F: Modulo inserti a bussola da 1/2" esagonali e XZN
- FG 100/23C: Modulo 14 utensili a percussione da 1/2"
- FG 100/56C: Modulo utensili da percussione



### 5° CASSETTO

- FG 100/10C: Modulo 8 chiavi a T snodate esagonali

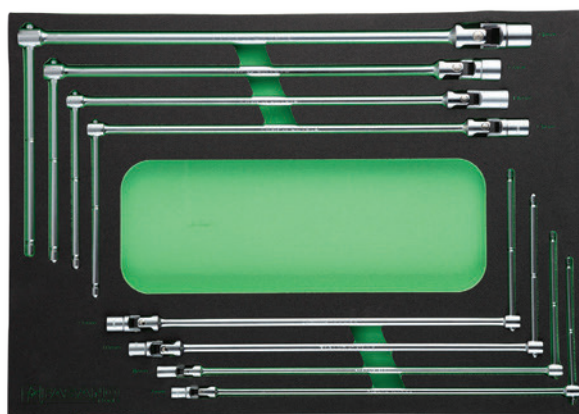



# CARRELLI E BANCHI DA LAVORO

**FG 104V/AS248**

**CARRELLO PORTA UTENSILI FG 104  
A 7 CASSETTI CON ASSORTIMENTO  
248 UTENSILI IN MODULI DI GOMMA**

~~3.597,00€~~

**1.499,00€**



**PORTATA  
STATICA**

CODICE				€/LISTINO	€/PROMO
FG 104V/AS248	FG 104D/AS248	FG 104B/AS248	FG 104R/AS248	3.597,00-	1.499,00

## 1°CASSETTO

- **FG 100/03G:** Modulo 14 chiavi combinate 6 - 19mm
- **FG 100/03L:** Modulo 6 chiavi combinate 21 - 32mm
- **FG 100/VA4:** Modulo di riempimento con vani porta minuteria
- **FG 100/21H:** Modulo 32 chiavi a bussola esagonali da 1/2" 8-32m + acc.



## 2°CASSETTO

- **FG 100/17E:** Modulo 65 utensili da 1/4"
- **FG 100/21TX:** Modulo 44 utensili con impronta Torx
- **FG 100/81F:** Modulo inserti a bussola da 1/2" esagonali e XZN
- **FG 100/23C:** Modulo 20 chiavi a bussola rinforzate da 1/2"



## 3°CASSETTO

- **FG 100/42C:** Modulo 4 pinze per anelli elastici 19-60mm
- **FG 100/39C:** Modulo 3 pinze
- **FG 100/45E:** Modulo 8 giraviti ad intaglio e a croce Phillips
- **FG 100/45I:** Modulo 6 giraviti con impronta Torx



## 4°CASSETTO

- **FG 100/65B:** Modulo pinza autobloccante e pinza regolabile a cerniera
- **FG 100/10D:** Modulo 12 chiavi a T snodate esagonali

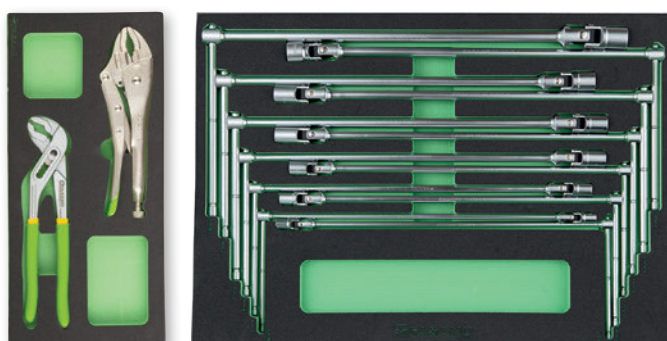



**FG 160V/AS304**

**CARRELLO PORTA UTENSILI A 14 CASSETTI  
MOD. FG 160 CON ASSORTIMENTO  
304 UTENSILI IN MODULI DI GOMMA**

~~5.470,50€~~ **2.699,00€**



**KG 2.400** **PORTATA STATICA**

CODICE			€/LISTINO	€/PROMO
FG 160B/AS304	FG 160R/AS304	FG 160D/AS304	5.470,50	2.699,00

## 6 CASSETTI COMPLETI DI UTENSILI

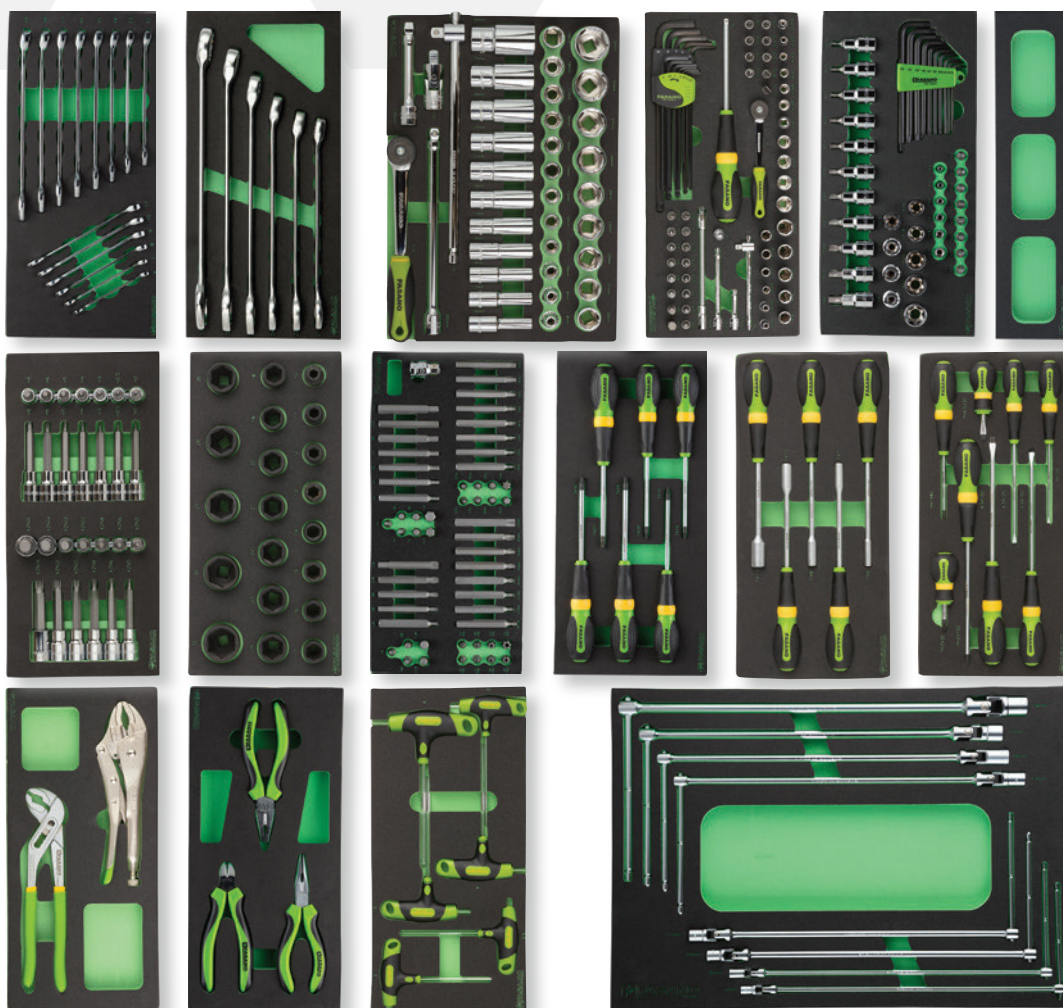

- **FG 100/03G:** Modulo 14 chiavi combinate 6 - 19mm
- **FG 100/03L:** Modulo 6 chiavi combinate 21 - 32mm
- **FG 100/21H:** Modulo 32 chiavi a bussola esagonali da 1/2" 8-32mm + acc.
- **FG 100/17E:** Modulo 65 utensili da 1/4"
- **FG 100/21TX:** Modulo 44 utensili con impronta Torx
- **FG 100/VA4:** Modulo di riempimento con vani porta minuteria
- **FG 100/81F:** Modulo inserti a bussola da 1/2" esagonali e XZN
- **FG 100/23C:** Modulo 14 utensili a percussione da 1/2"

- **FG 100/48G:** Modulo 52 inserti da 10mm
- **FG 100/45I:** Modulo 6 giraviti con impronta TORX
- **FG 100/45T:** Modulo 6 giraviti a bussola esagonali
- **FG 100/45E:** Modulo 8 giraviti ad intaglio e a croce Phillips
- **FG 100/65B:** Modulo pinza autobloccante e pinza regolabile a cerniera aperta
- **FG 100/39C:** Modulo 3 pinze assortite
- **FG 100/50F:** Modulo 6 chiavi maschio esagonali con impugnatura
- **FG 100/10C:** Modulo 8 chiavi a T snodate 7-19mm



# CARRELLI E BANCHI DA LAVORO



FG 100/03G

~~127,00€~~ 75,00€

**MODULO 14 CHIAVI COMBinate**

6, 7, 8, 9, 10, 11, 12, 13, 14, 15, 16, 17, 18, 19 mm



FG 100/03L

~~128,00€~~ 76,90€

**MODULO 6 CHIAVI COMBinate**

21, 22, 24, 27, 30, 32mm



FG 100/03E

~~75,00€~~ 45,90€

**MODULO 8 CHIAVI A DOPPIA FORCHETTA**

+ SET CHIAVI MASCHIO CON IMPRONTA ESAGONALE

6x7-20x22 mm + 139C/FS



FG 100/03F

~~79,00€~~ 48,50€

**MODULO 5 CHIAVI A DOPPIA FORCHETTA**

21x23, 24x26, 25x28, 27x29, 30x32 mm



FG 100/07C

~~85,00€~~ 49,90€

**MODULO 7 CHIAVI DOPPIE POLIGONALI**

6x7, 8x9, 10x11, 12x13, 14x15, 16x17, 18x19mm



FG 100/08C

~~200,00€~~ 119,00€

**MODULO 8 CHIAVI COMBinate A CRICCO**

8, 10, 11, 12, 13, 14, 15, 16, 17, 18, 19mm



FG 100/10C

**MODULO 8 CHIAVI A T SNODATE ESAGONALI**

7, 8, 10, 11, 13, 14, 17, 19 mm

~~275,00€~~

169,00€

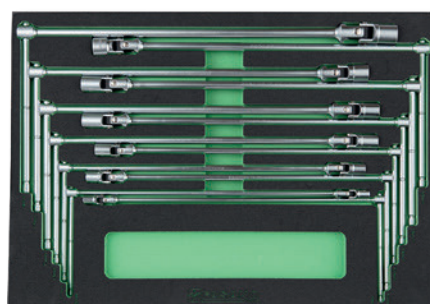

FG 100/10D

**MODULO 12 CHIAVI A T SNODATE ESAGONALI**

7, 8, 10, 11, 12, 13, 14, 15, 16, 17, 18, 19 mm

~~410,00€~~

249,00€



FG 100/17

~~115,00€~~ 69,90€

**MODULO 18 UTENSILI DA 1/4"**

4-14mm



FG 100/17E

~~255,00€~~ 152,50€

**MODULO 65 UTENSILI DA 1/4"**



**FG 100/21B**

**MODULO 25 UTENSILI DA 1/2"**  
10-32mm ESAGONALI

~~220,00€~~ **129,90€**



**FG 100/21C**

**MODULO 25 UTENSILI DA 1/2"**  
10-32mm POLIGONALI

~~220,00€~~ **129,90€**



**FG 100/21M**

**MODULO 16 UTENSILI DA 1/2"**  
10-32mm ESAGONALI

~~150,00€~~ **89,90€**

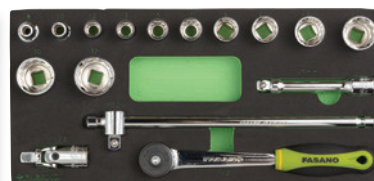

**FG 100/21D**

**MODULO 16 UTENSILI DA 1/2"**  
10-32mm POLIGONALI

~~150,00€~~ **89,90€**



**FG 100/21H**

**MODULO 32 CHIAVI A BUSSOLA ESAGONALI 1/2" + ACCESSORI**

BUSSOLE CORTE: 8-32mm  
(esclusa 25mm)  
BUSSOLE LUNGHE: 10-32mm

~~385,00€~~ **229,00€**

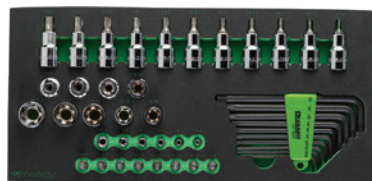

**FG 100/21TX**

**MODULO 44 UTENSILI TORX**

~~230,00€~~ **139,00€**



**FG 100/81F**

**MODULO INSERTI A BUSSOLA DA 1/2" ESAGONALI XZN**

~~320,00€~~ **149,00€**

**FG 100/25**

**MODULO 9 UTENSILI DA 3/4"**  
34-50mm ESAGONALI

~~375,00€~~  
**229,00€**



**FG 100/25B**

**MODULO 9 UTENSILI DA 3/4"**  
34-50mm POLIGONALI

~~375,00€~~  
**229,00€**

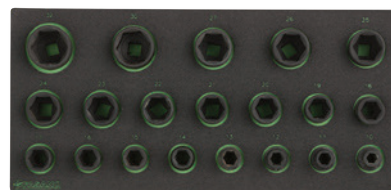

**FG 100/23C**

**MODULO 20 UTENSILI RINFORZATI DA 1/2"**

10, 11, 12, 13, 14, 15, 16, 17, 18, 19, 20, 21, 22, 23, 24, 25, 26, 27, 30, 32mm

~~200,00€~~ **122,50€**



**FG 100/39C**

**MODULO 3 PINZE SOFT-RUN**  
FG 59SR/180, FG 61SR/160, FG 63SR/160

~~82,50€~~ **49,90€**



**FG 100/65B**

**MODULO PINZA AUTOBLOCCANTE E PINZA REGOLABILE A CERNIERA APERTA**

~~62,00€~~ **37,90€**



**FG 100/41C**

**MODULO 4 PINZE PER ANELLI ELASTICI**  
Capacità: 8-25mm

~~95,00€~~ **57,90€**



**FG 100/42C**

**MODULO 4 PINZE PER ANELLI ELASTICI**  
Capacità: 19-60mm

~~100,00€~~ **61,50€**





# CARRELLI E BANCHI DA LAVORO



FG 100/45D

~~52,00€~~

31,90€

**MODULO 6 GIRAVITI AD INTAGLIO E A CROCE PHILLIPS**  
3x100, 4x125, 5.5x150, 6.5x150, PH1x80, PH2x150



FG 100/45E

~~62,00€~~

37,90€

**MODULO 8 GIRAVITI AD INTAGLIO E A CROCE PHILLIPS**  
3x100, 4x125, 5.5x150, 6.5x150, 6.5x38PH1x80, PH2x150, PH2x38



FG 100/45I

~~67,50€~~

39,90€

**MODULO 6 GIRAVITI TORX**  
TX10, TX15, TX20, TX25, TX27, TX30



FG 100/45T

~~67,50€~~

39,90€

**MODULO 5 GIRAVITI A BUSSOLA ESAGONALI**  
FX6, FX7, FX8, FX10, FX13

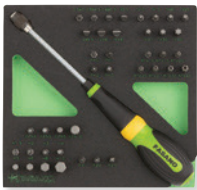

FG 100/48D

~~98,00€~~

59,90€

**MODULO 40 INSERTI DA 1/4" + PORTA INSERTI**

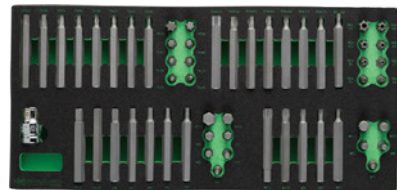

FG 100/48G

~~116,00€~~

69,90€

**MODULO 52 INSERTI DA 10MM**

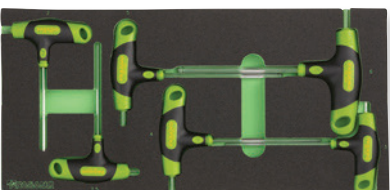

FG 100/50F

~~75,00€~~

45,90€

**MODULO 6 CHIAVI MASCHIO ESAGONALI**  
2, 2.5, 3, 4, 5, 6mm

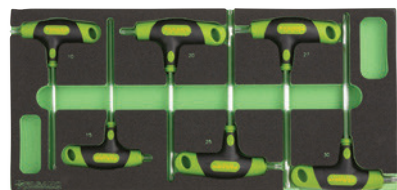

FG 100/50G

~~75,00€~~

45,90€

**MODULO 6 CHIAVI MASCHIO TORX**  
TX10, TX15, TX20, TX25, TX27, TX30



FG 100/56

~~95,00€~~

56,90€

**MODULO UTENSILI DA PERCUSSIONE**



FG 100/56C

~~110,00€~~

65,90€

**MODULO UTENSILI DA PERCUSSIONE**  
FG 132/500, FG 136/40, FG 126/SN1, FG 126/SN3



FG 107/A

NEW

## CARRELLO PORTA ATTREZZI IN LAMIERA D'ACCIAIO

- Dimensione: 380x730x780mm
- 2 ruote fisse e 2 ruote girevoli con freno (Ø 100mm)
- Peso totale: 16.4Kg

~~180,00€~~

**89,00€**



MANIGLIONE LATERALE  
IN LAMIERA D'ACCIAIO



4 RUOTE Ø 100MM  
(2 GIREVOLI FRENANTI  
E 2 FISSE)



RIPIANO CON BORDO RIALZATO  
(PROFONDITA' 75MM)



FG 106/B

## CARRELLO PORTA ATTREZZI IN LAMIERA D'ACCIAIO

- Dimensione: 460x930x885mm
- Lamiera d'acciaio 1.5mm
- Ruote montate su supporto rotante a piastra con gruppo rotante realizzato con doppia corona di sfere
- 2 ruote fisse, 1 girevole + 1 girevole con freno (Ø100mm)
- Peso totale: 22.0Kg

~~265,00€~~

**159,00€**

MADE IN ITALY



FG 106/C

## CARRELLO PORTA ATTREZZI IN LAMIERA D'ACCIAIO - MOD. GIGANTE

- Dimensione: 560x1.000x950mm
- Lamiera d'acciaio 2.0mm
- Ruote montate su supporto rotante a piastra con gruppo rotante realizzato con doppia corona di sfere
- 2 ruote fisse, 1 girevole + 1 girevole con freno (Ø125mm)
- Peso totale: 44.0Kg

~~360,00€~~

**179,00€**

MADE IN ITALY



## CARRELLI E BANCHI DA LAVORO

**FG 129/1**

**BANCO DA LAVORO 1.0MT  
- SENZA CASSETTO**

Peso totale: 58Kg

Dimensione: 1.000x745x880 mm

~~437,00€~~

**229,00€**

**MADE IN ITALY**



**FG 129/1.5**

**BANCO DA LAVORO 1.5MT  
- SENZA CASSETTO**

Peso totale: 77Kg

Dimensione: 1.500x745x880 mm

~~500,00€~~

**269,00€**

**MADE IN ITALY**

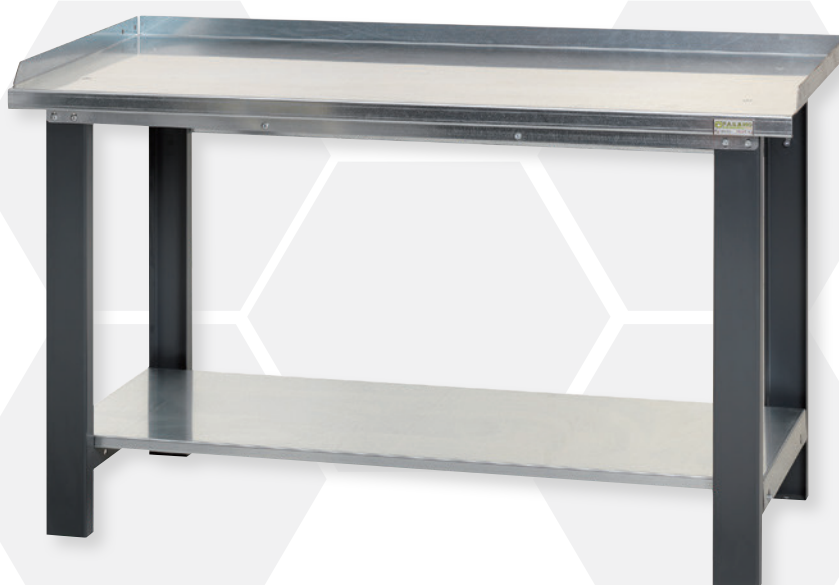

**FG 129/2**

**BANCO DA LAVORO 2.0MT  
- SENZA CASSETTI**

Peso totale: 100Kg

Dimensione: 2.000x745x880 mm

~~635,00€~~

**359,00€**

**MADE IN ITALY**

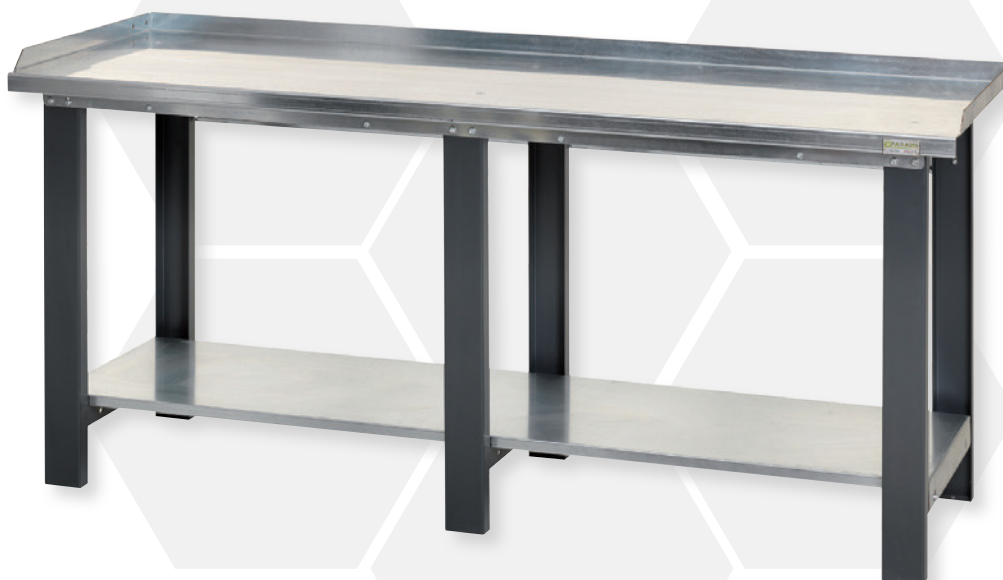



MADE IN ITALY

~~520,00€~~

269,00€

FG 129/D1

**BANCO DA LAVORO 1.0MT CON CASSETTI DI COLORE GRIGIO DARK**

Peso totale: 64,50Kg

Dimensione: 1.000x745x880mm

FG 129/B1



FG 129/R1



MADE IN ITALY

~~625,00€~~

319,00€

FG 129/D1.5

**BANCO DA LAVORO 1.5MT CON CASSETTI DI COLORE GRIGIO DARK**

Peso totale: 83,50Kg

Dimensione: 1.500x745x880mm

FG 129/B1.5



FG 129/R1.5



MADE IN ITALY

FG 129/D2

**BANCO DA LAVORO 2MT CON CASSETTI DI COLORE GRIGIO DARK**

Peso totale: 106,50Kg

Dimensione: 2.000x745x880mm

~~780,00€~~

429,00€

FG 129/B2



FG 129/R2





# CARRELLI E BANCHI DA LAVORO



**FG 131/D2**

BANCO DA LAVORO 2.0MT CON RIPIANO  
IN ACCIAIO, CASSETTIERA 5 CASSETTI

~~1.450,00€~~ **879,00€**

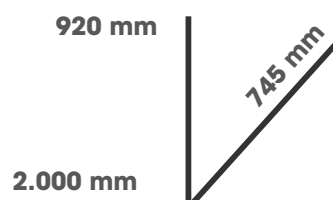

**FG 131/R2**

**FG 131/B2**

**MADE IN ITALY**



**FG 132/D2**

BANCO DA LAVORO 2.0MT CON RIPIANO  
IN ACCIAIO, 2 CASSETTIERE 5 CASSETTI

~~2.000,00€~~ **1.199,00€**

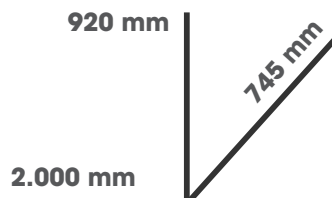

**FG 132/R2**

**FG 132/B2**

**MADE IN ITALY**



MADE IN ITALY

**FG 134/D2**

BANCO DA LAVORO 2.0MT CON RIPIANO IN ACCIAIO, CASSETTIERA 5 CASSETTI E PARETE PORTAUTENSILI

~~2.650,00€~~

**1.599,00€**

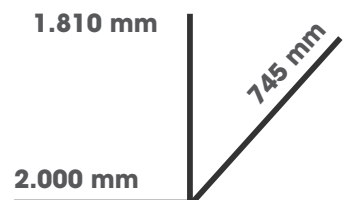

**FG 134/R2**

**FG 134/B2**



MADE IN ITALY

**FG 135/D2**

BANCO DA LAVORO 2.0MT CON RIPIANO IN ACCIAIO, 2 CASSETTIERE 5 CASSETTI E PARETE PORTAUTENSILI

~~3.200,00€~~

**1.899,00€**

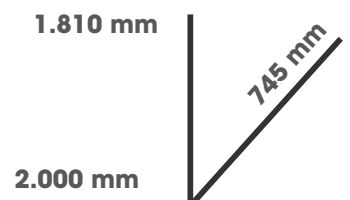

**FG 135/R2**

**FG 135/B2**



# CARRELLI E BANCHI DA LAVORO



**FG 133/D2**

## BANCO DA LAVORO 2.0MT CON CASSETTI E PARETE PORTAUTENSILI DI COLORE GRIGIO DARK

- Ripiano superiore in lamiera d'acciaio 3mm
- Ripiano inferiore in lamiera d'acciaio 3mm fornita di serie
- 2 cassetti dotati di sistema di chiusura con chiave
- Predisposizione per fissaggio a pavimento
- Struttura verniciata con vernice epossidica
- Parete portautensili con tapparella in alluminio e serratura

**FG 133/R2**

**FG 133/B2**

~~2.000,00€~~ **1.099,00€**

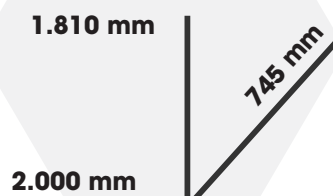

**MADE IN ITALY**



**FG 137/D1.5**

**BANCO DA LAVORO 1.5MT  
CON VASCA DI RACCOLTA  
DI COLORE GRIGIO DARK  
E RUOTE GIREVOLI**

Peso totale: 90,00Kg  
Dimensione: 1.500x745x880mm

~~1.230,00€~~ **699,00€**

**RIPIANO MICRO FORATO**

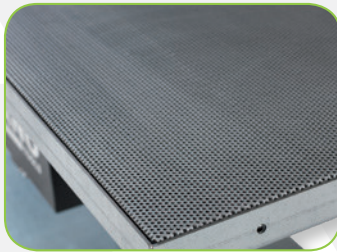

**FG 137/R1.5**

**FG 137/B1.5**



**FG 131/A1**

~~1.180,00€~~ **629,00€**

**BANCO DA LAVORO 1.0MT  
- RIPIANO IN ACCIAIO INOX  
E RUOTE GIREVOLI (2 FRENANTI)**

Dimensione: 1.000x750x920 mm



**FG 131/D1**

~~850,00€~~ **499,00€**

**BANCO DA LAVORO 1.0MT  
- RIPIANO IN LAMIERA D'ACCIAIO  
E RUOTE (2 FRENANTI)**

Dimensione: 1.000x750x920 mm



## ARREDAMENTO TECNICO



## MODULAR FORMS

LA LINEA DI ARREDAMENTO TECNICO FASANO TOOLS OFFRE LA POSSIBILITÀ DI CREARE UN AMBIENTE DI LAVORO MODERNO, MODELLATO SUI TUOI SPAZI E SULLE TUE NECESSITÀ.

SCEGLI TRA UN'AMPIA GAMMA DI SOLUZIONI TUTTE ACCOMUNATE DA ELEVATI STANDARD QUALITATIVI E STUDIATE CON L'OBIETTIVO DI SFRUTTARE AL MEGLIO IL TUO SPAZIO DI LAVORO.



## PERSONALIZZIAMO

IL COLORE DELLE COMPOSIZIONI  
SECONDO I TUOI GUSTI  
O IN BASE AI TUOI COLORI  
AZIENDALI



## PROGETTIAMO

IL TUO AMBIENTE DI LAVORO IN BASE  
AI TUOI SPAZI E ALLE TUE ESIGENZE





# ARREDAMENTO TECNICO

FG 118/AS119V

NEW

CONFIGURAZIONE ARREDAMENTO  
TECNICO DA 2.050MM  
CON ASSORTIMENTO UTENSILI

~~5.976,00€~~

2.999,00€

2.000 mm

757 mm

2.050 mm



FG 118/AS119V



FG 118/AS119B



FG 118/AS119R

MADE IN ITALY



## ASSORTIMENTO 119PZ IN OMAGGIO

### COMPOSIZIONE PARETE ATTREZZATA:

- FG 118V/69A: Modulo armadietto a 2 ante
- FG 118V/7T: Cassetiera mobile a 7 cassetti
- FG 118V/40F: Modulo porta carta, con cassetto porta rifiuti
- 02 pensili superiori dotati di pistoni a gas e serratura
- 02 griglie porta utensili
- 01 presa di corrente composta da 1 presa 220V a 2 poli, 1 presa Shuko a 2 poli cadauna, USB

### CONTENUTO ASSORTIMENTO 119pz:

- FG 102/03G: Modulo 14 chiavi combinate 6 - 19mm
- FG 102/21E: Modulo chiavi a bussola 1/2" 8-32mm+acc.
- FG 102/17: Modulo chiavi a bussola 1/4" 4-14mm+acc.
- FG 102/39D: Modulo 3 pinze
- FG 102/48G: Modulo INSERTI CON ATTACCO 10mm
- FG 102/45F: Modulo 6 giraviti a taglio
- FG 102/45G: Modulo 6 giraviti a croce
- FG 102/65B: Modulo pinza autobloccante e pinza a cerniera
- FG 102/VA1: Modulo porta minuterie



## RISPARMI OLTRE 600,00€ !

## FG 118/C03V

### CONFIGURAZIONE DI ARREDAMENTO TECNICO DA 2.050M DOTATA DI PENSILI SUPERIORI, GRIGLIE PORTA UTENSILI E ARMADIETTO LATERALE AD 1 ANTINA

Configurazione composta da:

- FG 118V/69A (Modulo armadietto a 2 antine)
- FG 118/69V7 (Cassettiera mobile a 7 cassetti)
- FG 118V/40F (Modulo porta carta dotato di cassetto porta rifiuti)
- FG 118/AR1V (Armadietto ad 1 antina)
- 02 pensili superiori dotati di pistoni a gas e serratura di chiusura
- 02 griglie porta utensili
- 02 prese di corrente composte da 1 presa 220V a 2 poli, 1 presa Shuko a 2 poli cadauna, USB



FG 118/C03B



FG 118/C03R

~~5.925,00€~~

**3.199,00€**

MADE IN ITALY

## FG 118/C08V

### CONFIGURAZIONE DI ARREDAMENTO TECNICO DA 1.220M DOTATA DI PENSILE SUPERIORE E GRIGLIA PORTA UTENSILI

Configurazione composta da:

- FG 118/69V7 (Cassettiera fissa a 7 cassetti)
- FG 118M/40F (Modulo porta carta, dotato di cassetto porta rifiuti)
- Pensile superiore dotato di pistoni a gas e serratura di chiusura
- 01 griglia porta utensili semplice
- 02 prese di corrente composte da 1 presa 220V a 2 poli, 1 presa Shuko a 2 poli cadauna, USB



MADE IN ITALY



FG 118/C08B



FG 118/C08R

~~3.480,00€~~

**1.899,00€**

# ARREDAMENTO TECNICO



**FG 118/C020V**

~~12.930,00€~~ **6.899,00€**

## CONFIGURAZIONE DI ARREDAMENTO TECNICO DA 5.600M

Configurazione composta da:

- 04 pensili superiori dotati di pistoni a gas
- FG 118V/69A (Modulo armadietto a 2 antine)
- FG 118V/7T (Cassettiera mobile a 7 cassetti)
- FG 118V/40F (Modulo porta carta dotato di cassetto porta rifiuti)
- FG 118V/69E (Modulo porta rifiuti, dotato di contenitori)
- FG 118M/40D (Modulo distribuzione aria compressa)
- FG 118/69V7 (Cassettiera fissa a 7 cassetti)
- FG 118/AR1V (Armadietto laterale da 500mm)
- FG 118/AR3V (armadietto laterale con cassettiera interna)



**FG 118/C020B**



**FG 118/C020R**



**FG 118/C021V**

~~15.975,00€~~ **8.699,00€**

## CONFIGURAZIONE DI ARREDAMENTO TECNICO COMPLETA DA 5.650MM

Configurazione composta da:

- 02 pensili superiori dotati di pistoni a gas
- 01 griglia porta utensili dotata di sistema di chiusura a tapparella
- FG 118V/69A (Modulo armadietto a 2 antine)
- FG 118V/7T (Cassettiera mobile a 7 cassetti)
- FG 118V/40F (Modulo porta carta dotato di cassetto porta rifiuti)
- FG 118M/69B (Modulo distribuzione olio, dotato di 2 pistole digitali conta litri)
- FG 118M/40D (Modulo distribuzione aria compressa)
- FG 118/69V7 (Cassettiera fissa a 7 cassetti)
- FG 118/AR1V (Armadietto laterale da 500mm)
- FG 118/AR3V (armadietto laterale da 1.000mm a 2 antine e cassettiera interna)



**FG 118/C021B**



**FG 118/C021R**

## FG 118/C09V

### CONFIGURAZIONE DI ARREDAMENTO TECNICO DA 2.050M

- Configurazione composta da:
- FG 118V/69E (Modulo porta rifiuti completo di contenitori interni)
  - FG 118M/40D (Modulo distribuzione aria compressa)
  - FG 118/69V7 (Cassettiera fissa a 7 cassetti)
  - 02 prese di corrente composte da 1 presa 220V a 2 poli, 1 presa Shuko a 2 poli cadauna, USB



FG 118/C09B



FG 118/C09R

MADE IN ITALY

~~5.025,00€~~

**2.699,00€**



## FG 118/C010V

### CONFIGURAZIONE DI ARREDAMENTO TECNICO DA 2.050M

- Configurazione composta da:
- FG 118V/69A (Modulo armadietto a 2 antine)
  - FG 118V/7T (Cassettiera mobile a 7 cassetti)
  - FG 118V/40F (Modulo porta carta, dotato di cassetto porta rifiuti)
  - 02 prese di corrente composte da 1 presa 220V a 2 poli, 1 presa Shuko a 2 poli cadauna, USB



FG 118/C010B



FG 118/C010R

MADE IN ITALY

~~4.805,00€~~

**2.599,00€**





PROFESSIONAL  
EQUIPMENT



## EQUIPMENT

NASCE UNA NUOVA GAMMA ALL'INTERNO DEL CATALOGO FASANO TOOLS:  
L'EQUIPMENT PROFESSIONALE PER I SETTORI AUTOMOTIVE E  
INDUSTRIA, FRUTTO DI UN ACCURATO LAVORO DI RICERCA E SVILUPPO,  
CARATTERIZZATO DALLA SOLITA ATTENZIONE ALLA QUALITÀ E AI DETTAGLI.

**FG 720/2T**

**NEW**

**SOLLEVATORE IDRAULICO A CARRELLO 2 TON  
- MODELLO CORTO E RIBASSATO**

~~440,00€~~

**199,00€**

Sistema di sollevamento ausiliario a pedale



Ruote in Nylon disponibili di ricambio



Sistema a doppio pistone

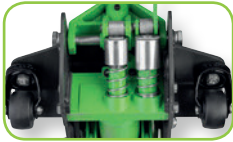

Contenitore porta minuterie integrato

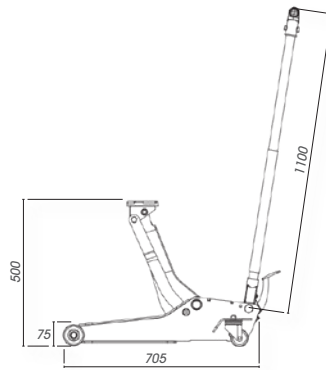

CE

SELF-RETURN INTEGRATO

**FG 722/2T**

**NEW**

**SOLLEVATORE IDRAULICO A CARRELLO 2 TON  
- MODELLO LUNGO E RIBASSATO**

~~530,00€~~

**229,00€**

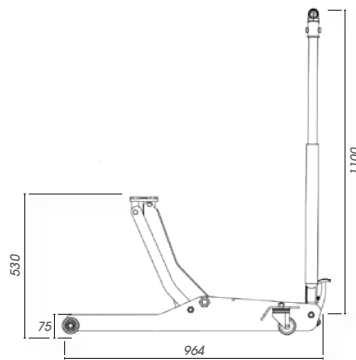

CE

SELF-RETURN INTEGRATO

**FG 722/5T**

**NEW**

**SOLLEVATORE IDRAULICO A CARRELLO 5 TON  
- MODELLO LUNGO PER MEZZI PESANTI**

~~1.190,00€~~

**699,00€**

Sistema di sollevamento ausiliario a pedale



Ruote in acciaio montate su cuscinetti a sfera

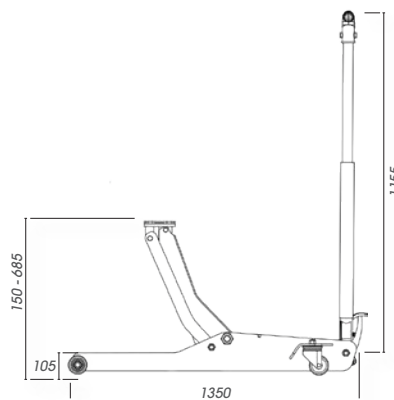

SELF-RETURN INTEGRATO

CE



FG 725/...T

**NEW**

COLONNETTE DI SOSTEGNO



CE

CODICE	CAPACITA'	H - MIN/MAX	€/PZ	€/PROMO
FG 725/3T	3 TON	285-425MM	76,00	<b>39,90</b>
FG 725/6T	6 TON	390-605MM	130,00	<b>69,00</b>
FG 725/12T	12 TON	495-720MM	230,00	<b>119,00</b>

FG 735/...T

**NEW**

SOLLEVATORI IDRAULICI A BOTTIGLIA



CE

CODICE	CAPACITA'	H - MIN/MAX	STELO	€/PZ	€/PROMO
FG 735/4T	4 TON	193-373MM	60MM	70,00	<b>39,90</b>
FG 735/6T	6 TON	214-416MM	70MM	82,00	<b>42,90</b>
FG 735/10T	10 TON	230-460MM	80MM	115,00	<b>59,90</b>
FG 735/16T	16 TON	230-440MM	60MM	130,00	<b>69,90</b>
FG 735/20T	20 TON	242-452MM	60MM	170,00	<b>89,90</b>

FG 750/A

**NEW**

CARRELLO MOVIMENTAZIONE VEICOLI  
- CAPACITÀ 680KG

~~340,00€~~

**179,00€**

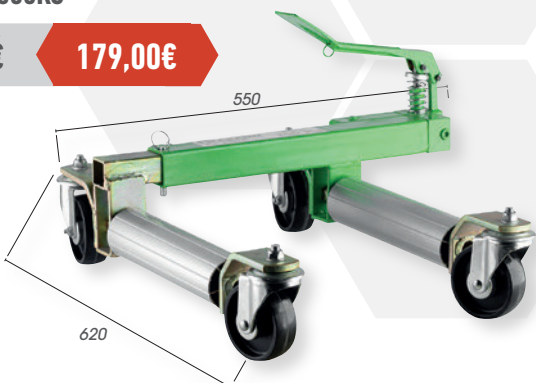

CE

- Sistema di sollevamento a pedale
- Dotato di 4 ruote girevoli

FG 740/0.5T

**NEW**

SOLLEVATORE IDRAULICO DA FOSSA E SOTTOPONTE  
- CAPACITÀ 500KG

~~530,00€~~

**279,00€**

- Sistema di sollevamento a pedale
- Dotato di 4 ruote girevoli



CE

FG 748/0.5T

**NEW**

SUPPORTO SOSTEGNO MOTORE  
- CAPACITÀ 500KG

~~210,00€~~

**109,00€**

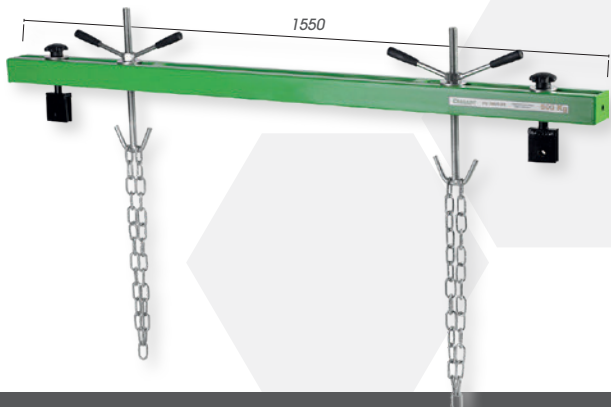

CE



### SICUREZZA TOTALE

Display digitale in grado di misurare la forza di compressione applicata



### AFFIDABILITA'

Le griffe sono prodotte in acciaio forgiato e sono dotate di un incavo profondo per garantire una presa totale della molla senza rischi di alcun genere per l'utilizzatore



### VELOCITA' D'USO

Lo speciale sistema autocentrante permette di posizionare i bracci con una sola mano e in modo rapido

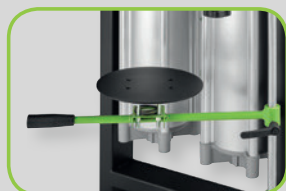

### PRECISIONE

La base d'appoggio inferiore, ottenuta in materiale gommoso, è dotata di bloccaggio a volantino e permette un posizionamento preciso dell'ammortizzatore

**MADE IN ITALY**



**FG 750/1P**

**NEW**

**SMONTA AMMORTIZZATORI  
DOTATO DI 1 PISTONE**

Potenza spinta: 1.2 ton (10 bar) - 0.9 ton (8 bar)  
Corsa di compressione molla: 300mm

~~2.250,00€~~

**1.199,00€**



**FG 750/2P**

**NEW**

**SMONTA AMMORTIZZATORI  
DOTATO DI 2 PISTONI**

Potenza spinta: 2.4 ton (10 bar) - 1.9 ton (8 bar)  
Corsa di compressione molla: 300mm

~~2.900,00€~~

**1.499,00€**



**FG 752/1P**

**NEW**

**SMONTA AMMORTIZZATORI  
DOTATO DI 1 PISTONE E  
DISPLAY DIGITALE**

Il display digitale visualizza la pressione applicata durante la fase di utilizzo

~~3.000,00€~~

**1.499,00€**



**FG 752/2P**

**NEW**

**SMONTA AMMORTIZZATORI  
DOTATO DI 2 PISTONI E  
DISPLAY DIGITALE**

Il display digitale visualizza la pressione applicata durante la fase di utilizzo

~~3.550,00€~~

**1.799,00€**

# PROFESSIONAL EQUIPMENT

Coperture anti polvere rimovibili



Serie di cacciaspina in dotazione



Sistema di regolazione ad argano



Piastre a V, regolabili a 180°



CE

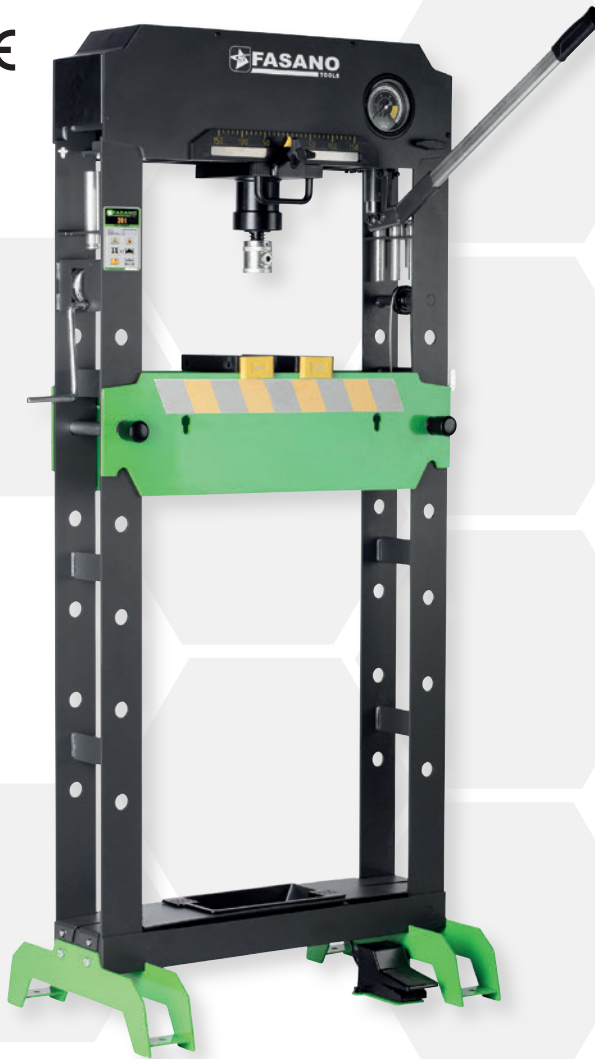

Manometro di facile lettura, integrato



Pistone mobile, con scala di misurazione

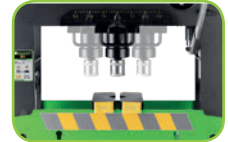

Speciale design per una maggiore regolabilità della base



Base d'appoggio rinforzata e dotata di contenitore porta minuterie



## PRESSE IDRAULICHE

MANUALE

NEW

PRESSA IDRAULICA  
MANUALE CON PISTONE  
MOBILE E ARGANO

CODICE	TON	€/LISTINO	€/PROMO
FG 732/20T	20 TON	1.915,00	990,00
FG 732/30T	30 TON	2.280,00	1.190,00

CE

PNEUMATICA

NEW

PRESSA IDRAULICA MANUALE  
E PNEUMATICA CON PISTONE  
MOBILE E ARGANO

CODICE	TON	€/LISTINO	€/PROMO
FG 732/20TP	20 TON	2.235,00	1.169,00
FG 732/30TP	30 TON	2.670,00	1.399,00
FG 732/50TP	50 TON	3.950,00	2.099,00

CE



CE

FG 730/20T

NEW



### PRESSA IDRAULICA MANUALE CON PISTONE FISSO

- Serie ECONOMY
- Base d'appoggio regolabile manualmente
- Manometro esterno, di facile lettura
- Struttura in acciaio



~~1.150,00€~~ **599,00€**

CE

FG 745/CMR

NEW

Sistema di rotazione a 360° a manovella



### CAVALLETTO SOSTEGNO MOTORE RICHIUDIBILE

- Versione richiudibile
- Possibilità di rotazione a 360°
- Ruote in acciaio per una maggiore durata e portata

~~850,00€~~ **459,00€**

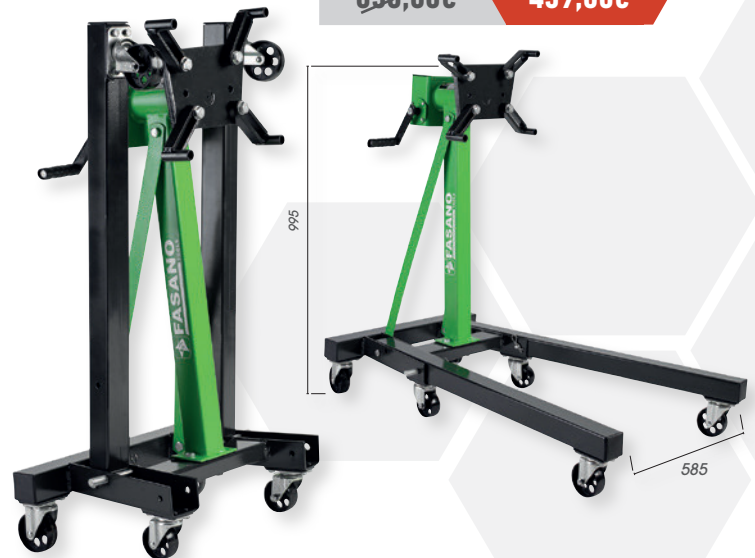

CE

Sistema di rotazione a 360°



FG 745/CMF

NEW

### CAVALLETTO SOSTEGNO MOTORE

- Possibilità di rotazione a 360°
- Ruote in acciaio per una maggiore durata e portata

~~370,00€~~ **199,00€**

CE



FG 738/1T

NEW

### GRU IDRAULICA PIEGHEVOLE CON POMPA A DOPPIO EFFETTO

- Capacità: 1 Ton
- Versione richiudibile
- Dotata di pompa a doppio effetto
- Ruote in acciaio per una maggiore durata e portata

~~960,00€~~ **499,00€**

FG 710/A



**LETTINO SOTTO MACCHINA  
IN PASTICA ANTI-URTO**

Dimensioni: 1.020x450x90mm

**KG  
136** PORTATA  
STATICA

~~80,00€~~ **42,50€**

FG 710/B



**LETTINO SOTTO  
MACCHINA RICHIUDIBILE**

Dimensioni da aperto: 910x415x120mm  
Dimensioni da chiuso: 540x415x150mm

**KG  
136** PORTATA  
STATICA

~~95,00€~~ **49,00€**

FG 710/C

**NEW**

**SEGGIOLINO GIREVOLE,  
DOTATO DI ACCESSORI**

~~135,00€~~ **69,90€**



FG 710/D

**NEW**

**SEGGIOLINO GIREVOLE,  
DOTATO DI ACCESSORI**

~~220,00€~~ **109,00€**



FG 712/A

**NEW**

**PORTA MINUTERIE/UTENSILI  
DOTATO DI RUOTE GIREVOLI**

- Dotato di 2 scomparti magnetici porta minuterie
- Dotato di 2 ampi scomparti porta utensili
- Dotato di piastra centrale magnetica
- 3 ruote girevoli da 500mm
- Materiale: ABS resistente agli urti

~~70,00€~~ **35,90€**



## FG 700/OZ3.5

### OZONIZZATORE 3.5 G/H - SERIE 700

- Sensore di saturazione: Sì
- Filtri a carboni attivi: Sì
- Stampante termica: No
- Case: Acciaio Inox
- Alimentazione: 12V e 220V
- Dimensioni: 335x200x160mm

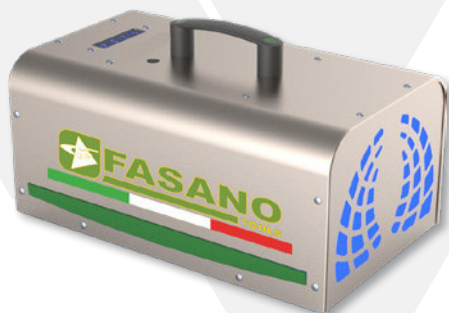

~~800,00€~~

**399,00€**

MADE IN ITALY

## FG 702/OZ3.5

### OZONIZZATORE 3.5 G/H - SERIE 702

- Sensore di saturazione: Sì
- Filtri a carboni attivi: Sì
- Stampante termica: Sì
- Case: Acciaio Inox
- Alimentazione: 12V e 220V
- Dimensioni: 335x200x160mm

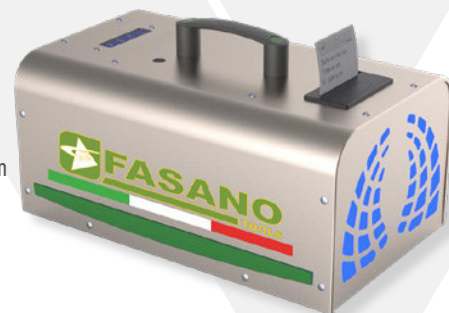

~~900,00€~~

**469,00€**

MADE IN ITALY

## FG 700/OZ5.0

### OZONIZZATORE 5.0 G/H - SERIE 700

- Sensore di saturazione: Sì
- Filtri a carboni attivi: Sì
- Stampante termica: No
- Case: Acciaio Inox
- Alimentazione: 220V
- Dimensioni: 335x200x160mm

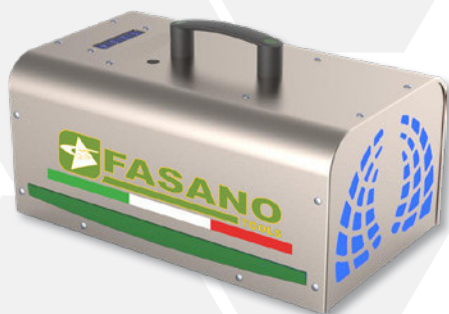

~~850,00€~~

**439,00€**

MADE IN ITALY

## FG 702/OZ5.0

### OZONIZZATORE 5.0 G/H - SERIE 702

- Sensore di saturazione: Sì
- Filtri a carboni attivi: Sì
- Stampante termica: Sì
- Case: Acciaio Inox
- Alimentazione: 220V
- Dimensioni: 335x200x160mm

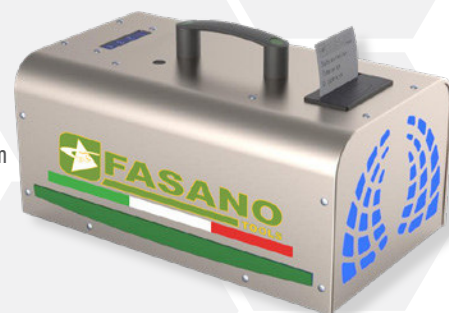

~~950,00€~~

**499,00€**

MADE IN ITALY

## FG 700/OZ10

### OZONIZZATORE 10.0 G/H - SERIE 700

- Sensore di saturazione: Sì
- Filtri a carboni attivi: Sì
- Stampante termica: No
- Case: Acciaio Inox
- Alimentazione: 220V
- Dimensioni: 335x350x160mm

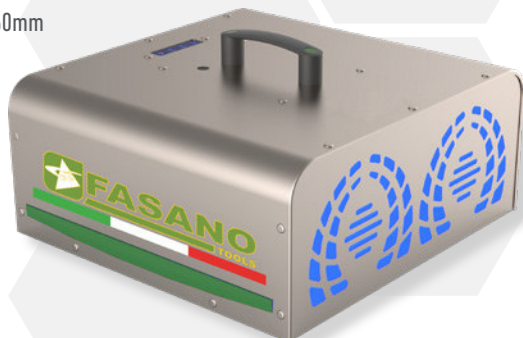

~~1.100,00€~~

**579,00€**

MADE IN ITALY

## FG 702/OZ10

### OZONIZZATORE 10.0 G/H - SERIE 702

- Sensore di saturazione: Sì
- Filtri a carboni attivi: Sì
- Stampante termica: Sì
- Case: Acciaio Inox
- Alimentazione: 220V
- Dimensioni: 335x350x160mm

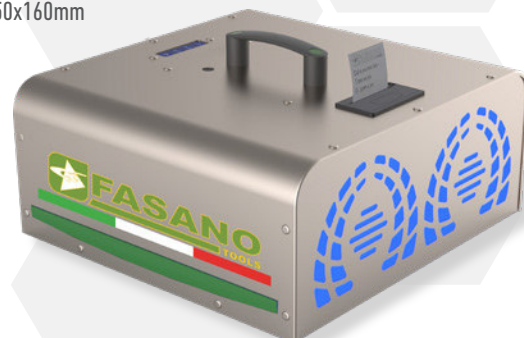

~~1.200,00€~~

**639,00€**

MADE IN ITALY







CODICE	PAGINA	€/Promo
FG 629B/S15	15	289,00
FG 700/OZ10	101	579,00
FG 700/OZ3.5	101	399,00
FG 700/OZ5.0	101	439,00
FG 702/OZ10	101	639,00
FG 702/OZ3.5	101	469,00
FG 702/OZ5.0	101	499,00
FG 710/A	100	42,50
FG 710/B	100	49,00
FG 710/C	100	69,90
FG 710/D	100	109,00
FG 712/A	100	35,90
FG 712/L4	27	79,00
FG 720/2T	95	199,00
FG 722/2T	95	229,00
FG 722/5T	95	699,00
FG 725/12T	96	119,00
FG 725/3T	96	39,90
FG 725/6T	96	69,00
FG 730/20T	99	599,00
FG 732/20T	98	990,00
FG 732/20TP	98	1.169,00
FG 732/30T	98	1.190,00
FG 732/30TP	98	1.399,00
FG 732/50TP	98	2.099,00
FG 735/10T	96	59,90
FG 735/16T	96	69,90
FG 735/20T	96	89,90
FG 735/4T	96	39,90
FG 735/6T	96	42,90
FG 738/1T	99	499,00
FG 740/0.5T	96	279,00
FG 745/CMF	99	199,00
FG 745/CMR	99	459,00
FG 748/0.5T	96	109,00
FG 750/1P	97	1.199,00
FG 750/2P	97	1.499,00
FG 750/A	96	179,00
FG 752/1P	97	1.499,00
FG 752/2P	97	1.799,00
FG 800/9	47	79,00
FG BEST 108	10	119,00
FG BEST 171	11	159,00
FG SERVICE 106	53	89,00
FGA 291/B	37	59,00
FGA 292/B	37	119,00
FGA 302	35	119,00
FGA 307	35	135,00
FGA 307AN/S13	37	189,00
FGA 309	35	159,00
FGA 312	35	199,00
FGA 316	36	399,00
FGA 316/L	36	449,00
FGA 319	36	559,00
FGA 319/L	36	619,00
FGA 321	36	559,00
FGA 321/B	36	589,00
FGA 321/C	37	599,00

CODICE	PAGINA	€/Promo
FGA 330	39	149,00
FGA 332	38	79,00
FGA 332/AN	38	96,00
FGA 333	38	99,00
FGA 333/AC	38	119,00
FGA 334	40	79,00
FGA 334/AN	40	99,00
FGA 334/AN115	40	99,00
FGA 334/L	40	99,00
FGA 335	39	99,00
FGA 336	39	299,00
FGA 337	39	69,00
FGA 338	40	62,50
FGA 338/AN	40	92,50
FGA 338/B	40	89,00
FGA 338/L	40	89,00
FGA 339	39	179,00
FGA 339/B	39	99,00
FGA 339/B50-G120	39	7,20
FGA 339/B50-G60	39	5,40
FGA 339/B50-G80	39	6,00
FGA 340	38	149,00
FGA 340/B	38	149,00
FGA 342	41	109,00
FGA 342/B	38	159,00
FGA 343/N10	41	119,00
FGA 343/N20	41	149,00
FGA 346/S4	41	99,00
FGA 382/AR15	41	109,00
FGA 384/AR15	41	129,00

WWW.FASANOTOOLS.COM

NEW

VISITA IL NOSTRO NUOVO SITO WEB!

**DISTRIBUTORE UFFICIALE**

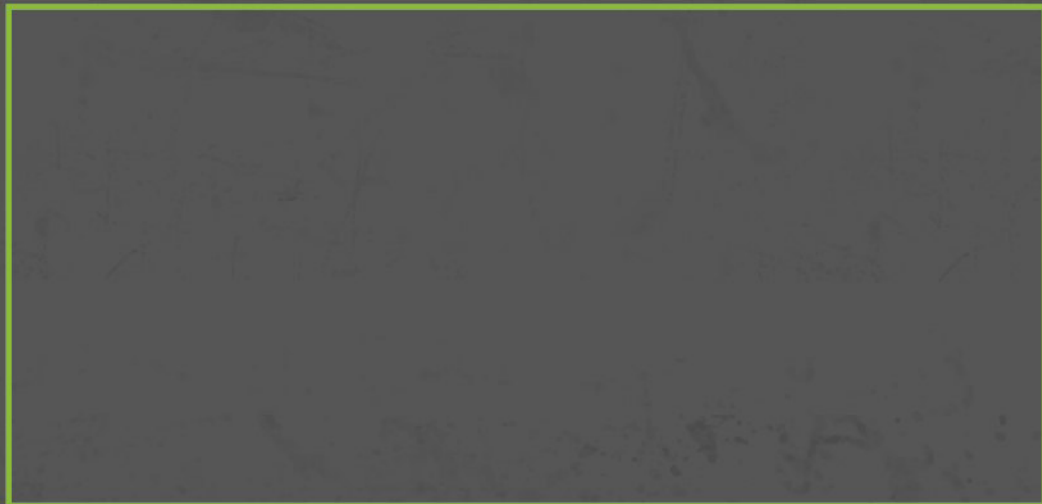

**fasanotools.com**

