

ALLESTIMENTO

FURGONI

CATALOGO GENERALE

**Nuovi moduli
in 3 varianti colore**

RAL
6018

RAL
5002

RAL
3001

Il lavoro on the road

Allestimento furgoni!

Ai nostri clienti offriamo il massimo della qualità e dell'efficienza anche su strada.

L'allestimento **Fasano Tools** per furgoni e veicoli commerciali offre la possibilità di creare l'ambiente di lavoro ideale per le proprie esigenze.

 **MADE IN ITALY** 



NUOVI MODULI

ALLESTIMENTO FURGONI



**MANIGLIE IN ABS
CON IMPUGNATURA
ERGONOMICA**



**CASSETTI CON
APERTURA COMPLETA
PER MODULI
PORTA UTENSILI**



**VALIGIE COMPONENTI
CON SCOMPARTI
PORTA MINUTERIE**



**ANTE ESTRAIBILI
AD APERTURA
TOTALE**



**VASCHE IN PLASTICA
PORTA MINUTERIE**

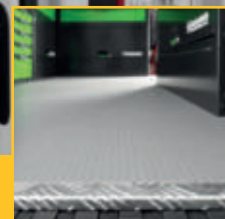

**PIANALI
ANTISCIVOLO**

LA SOLUZIONE MODULARE PER COMPORRE
L' ALLESTIMENTO DEL TUO FURGONE

in 3 facili STEP



STEP

BASE

1°

SELEZIONARE LA BASE:

- APERTA (SE POSIZIONATA SUL PASSARUOTA) OPPURE CHIUSA
- EVENTUALE RIALZO

STEP

CASSETTI

2°

SELEZIONARE LA CASSETTIERA

(LA TIPOLOGIA ED IL NUMERO DELLE CASSETTIERE VARIANO IN FUNZIONE DELLA LARGHEZZA DELLA BASE)

STEP

RIPIANI

3°

AGGIUNGERE EVENTUALI RIPIANI CON I RELATIVI MONTANTI LATERALI

(TENERE PRESENTE LA PROFONDITA' DELLA STRUTTURA E LA SAGOMA DEL FURGONE)



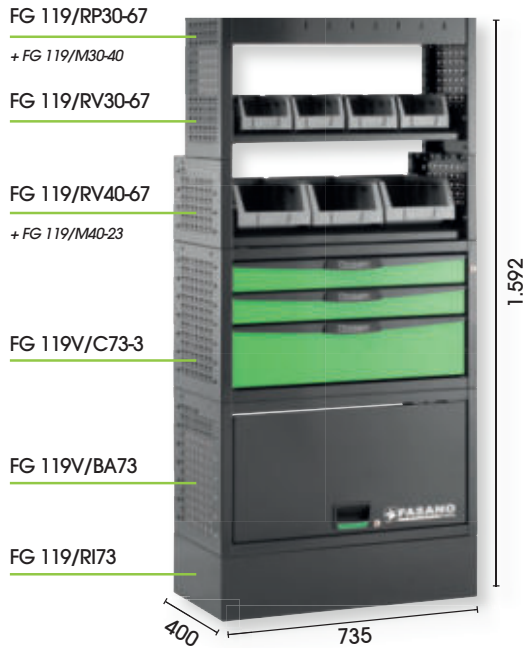

FG 119V/CO1
**CONFIGURAZIONE ALLESTIMENTO
TECNICO PER FURGONI**

Dimensioni: 735x400x1.592mm - Peso: 53,8 Kg



FG 119B/CO1

FG 119R/CO1

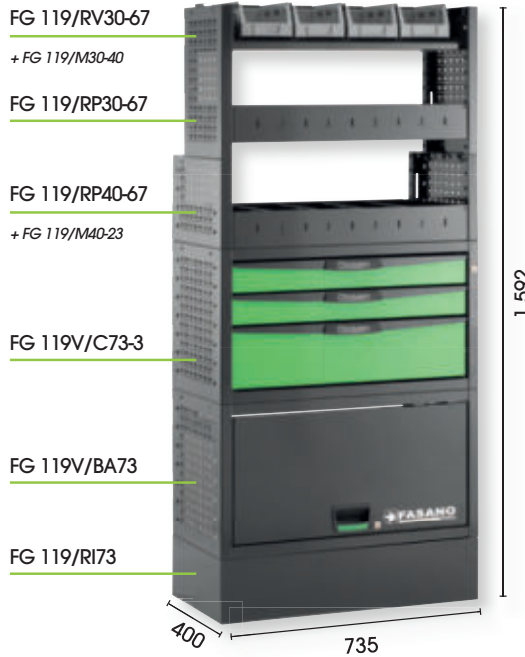

FG 119V/CO2

**CONFIGURAZIONE ALLESTIMENTO
TECNICO PER FURGONI**

Dimensioni: 735x400x1.592mm - Peso: 53,2 Kg



FG 119B/CO2

FG 119R/CO2

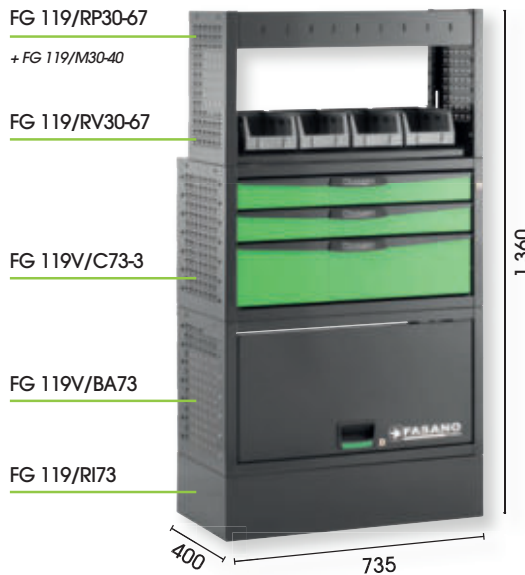

FG 119V/CO3

**CONFIGURAZIONE ALLESTIMENTO
TECNICO PER FURGONI**

Dimensioni: 735x400x1.360mm - Peso: 46,4 Kg



FG 119B/CO3

FG 119R/CO3

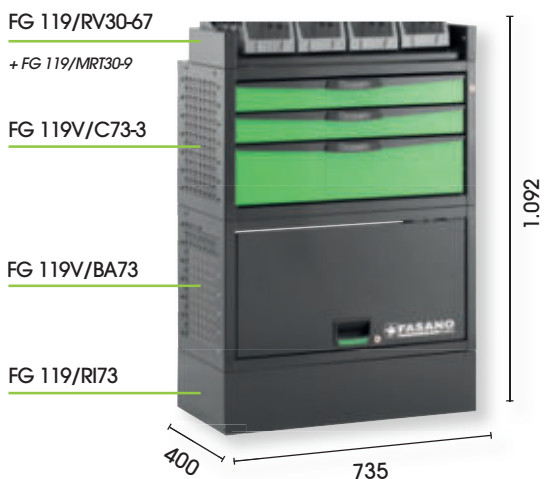

FG 119V/CO4

CONFIGURAZIONE ALLESTIMENTO TECNICO PER FURGONI

Dimensioni: 735x400x1.092mm - Peso: 40,9 Kg



FG 119B/CO4



FG 119R/CO4

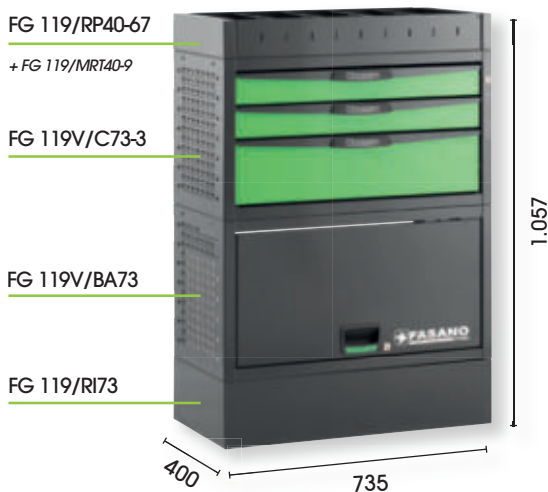

FG 119V/CO5

CONFIGURAZIONE ALLESTIMENTO TECNICO PER FURGONI

Dimensioni: 735x400x1.057mm - Peso: 42,26 Kg



FG 119B/CO5



FG 119R/CO5

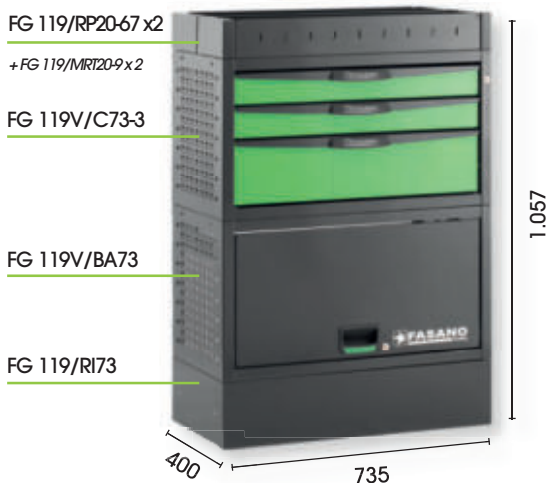

FG 119V/CO6

CONFIGURAZIONE ALLESTIMENTO TECNICO PER FURGONI

Dimensioni: 735x400x1.057mm - Peso: 43,9 Kg



FG 119B/CO6



FG 119R/CO6

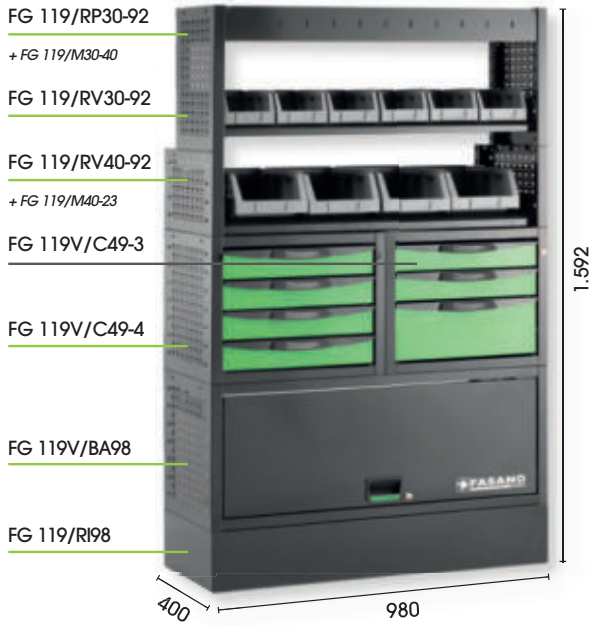

FG 119V/CO11 CONFIGURAZIONE ALLESTIMENTO TECNICO PER FURGONI

Dimensioni: 980x400x1.592mm - Peso: 75,6 Kg



FG 119B/CO11

FG 119R/CO11

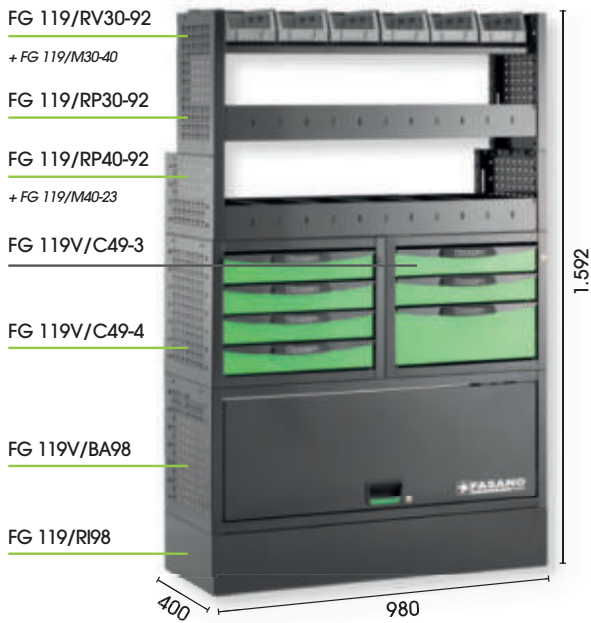

FG 119V/CO12 CONFIGURAZIONE ALLESTIMENTO TECNICO PER FURGONI

Dimensioni: 980x400x1.592mm - Peso: 74,69 Kg



FG 119B/CO12

FG 119R/CO12

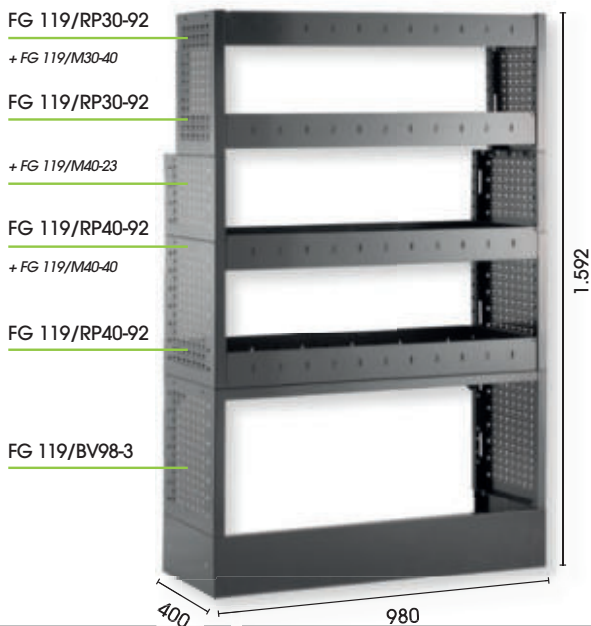

FG 119V/CO13 CONFIGURAZIONE ALLESTIMENTO TECNICO PER FURGONI

Dimensioni: 980x400x1.592mm - Peso: 40,4 Kg



SCOMPARTI PORTA UTENSILI



FG 119V/CO14

CONFIGURAZIONE ALLESTIMENTO TECNICO PER FURGONI

Dimensioni: 980x400x1.360mm - Peso: 43,9 Kg

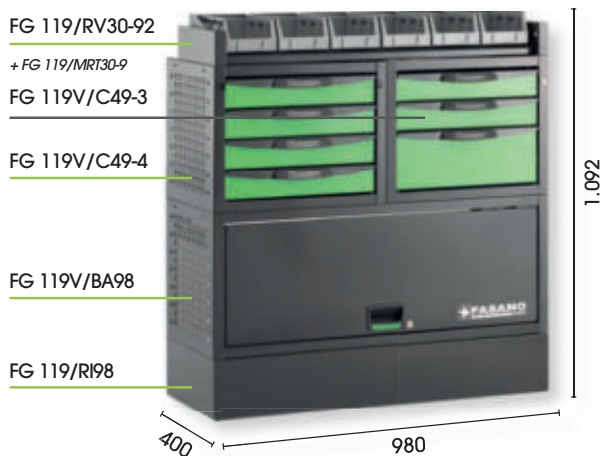
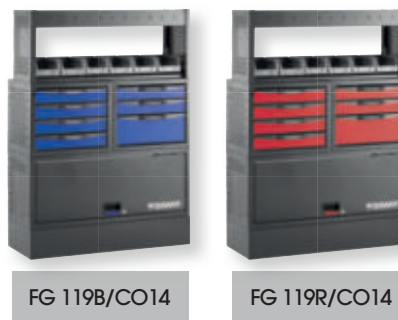

FG 119V/CO15

CONFIGURAZIONE ALLESTIMENTO TECNICO PER FURGONI

Dimensioni: 980x400x1.092mm - Peso: 59,9 Kg

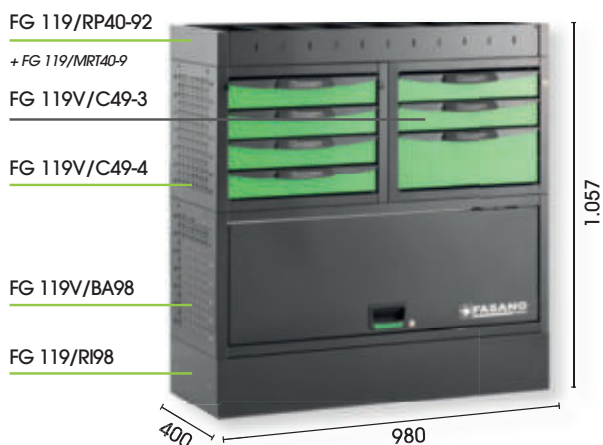

FG 119V/CO16

CONFIGURAZIONE ALLESTIMENTO TECNICO PER FURGONI

Dimensioni: 980x400x1.057mm - Peso: 61,8 Kg

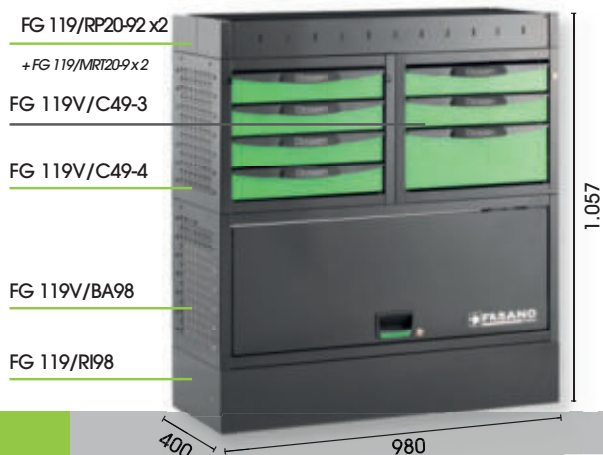

FG 119V/CO17

CONFIGURAZIONE ALLESTIMENTO TECNICO PER FURGONI

Dimensioni: 980x400x1.057mm - Peso: 63,6 Kg



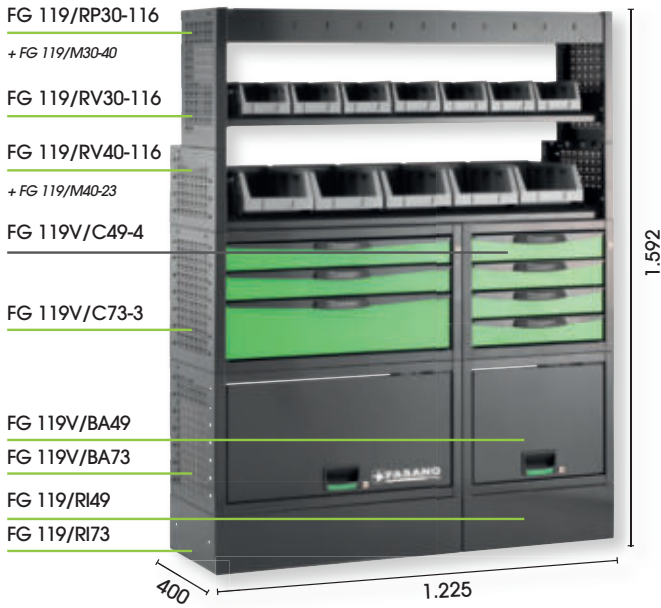

FG 119V/CO21

CONFIGURAZIONE ALLESTIMENTO TECNICO PER FURGONI

Dimensioni: 1.225x400x1.592mm - Peso: 92,4 Kg



FG 119B/CO21



FG 119R/CO21

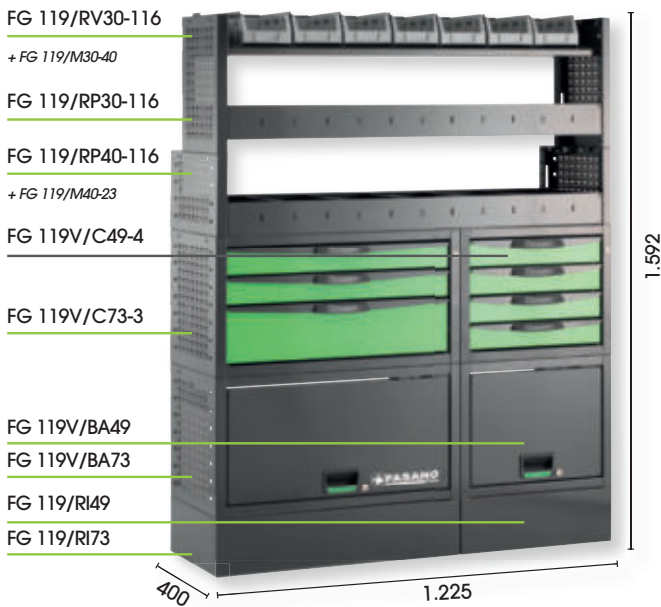

FG 119V/CO22

CONFIGURAZIONE ALLESTIMENTO TECNICO PER FURGONI

Dimensioni: 1.225x400x1.592mm - Peso: 91,2 Kg



FG 119B/CO22



FG 119R/CO22

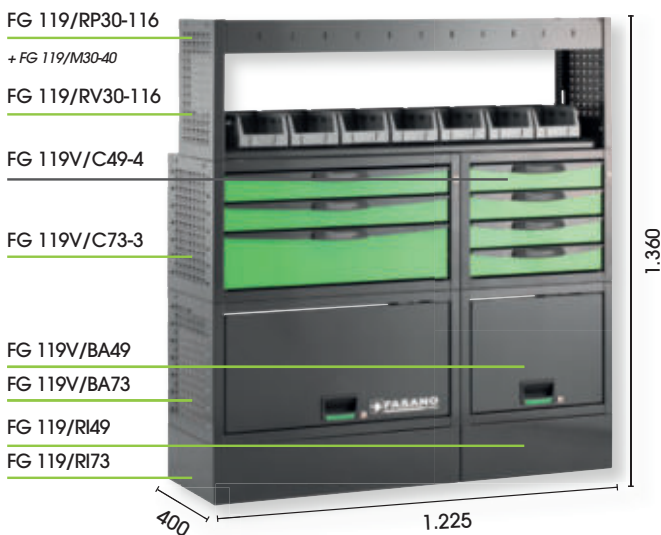

FG 119V/CO23

CONFIGURAZIONE ALLESTIMENTO TECNICO PER FURGONI

Dimensioni: 1.225x400x1.360mm - Peso: 81,8 Kg



FG 119B/CO23



FG 119R/CO23

FG 119/RV30-116

+ FG 119/MRT30-9

FG 119V/C49-4

FG 119V/C73-3

FG 119V/BA49

FG 119V/BA73

FG 119/RI49

FG 119/RI73



FG 119V/CO24

**CONFIGURAZIONE ALLESTIMENTO
TECNICO PER FURGONI**

Dimensioni: 1.225x400x1.092mm - Peso: 74,61Kg



FG 119B/CO24



FG 119R/CO24

FG 119/RP40-116

+ FG 119/MRT40-9

FG 119V/C49-4

FG 119V/C73-3

FG 119V/BA49

FG 119V/BA73

FG 119/RI49

FG 119/RI73



FG 119V/CO25

**CONFIGURAZIONE ALLESTIMENTO
TECNICO PER FURGONI**

Dimensioni: 1.225x400x1.057mm - Peso: 76,2Kg



FG 119B/CO25



FG 119R/CO25

FG 119/RP20-116x2

+ FG 119/MRT20-9x2

FG 119V/C49-4

FG 119V/C73-3

FG 119V/BA49

FG 119V/BA73

FG 119/RI49

FG 119/RI73



FG 119V/CO26

**CONFIGURAZIONE ALLESTIMENTO
TECNICO PER FURGONI**

Dimensioni: 1.225x400x1.057mm - Peso: 78,3Kg



FG 119B/CO26



FG 119R/CO26

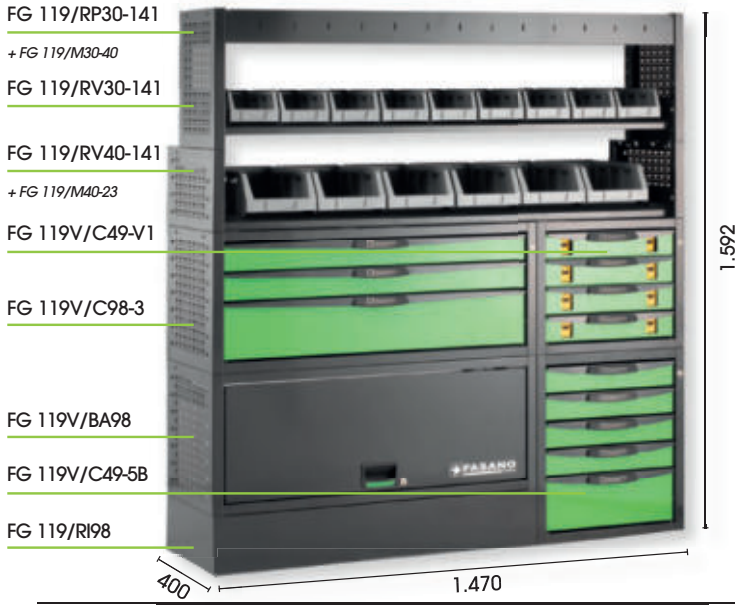

FG 119V/CO31
CONFIGURAZIONE ALLESTIMENTO
TECNICO PER FURGONI

Dimensioni: 1.470x400x1.592mm - Peso: 126,2Kg



FG 119B/CO31



FG 119R/CO31

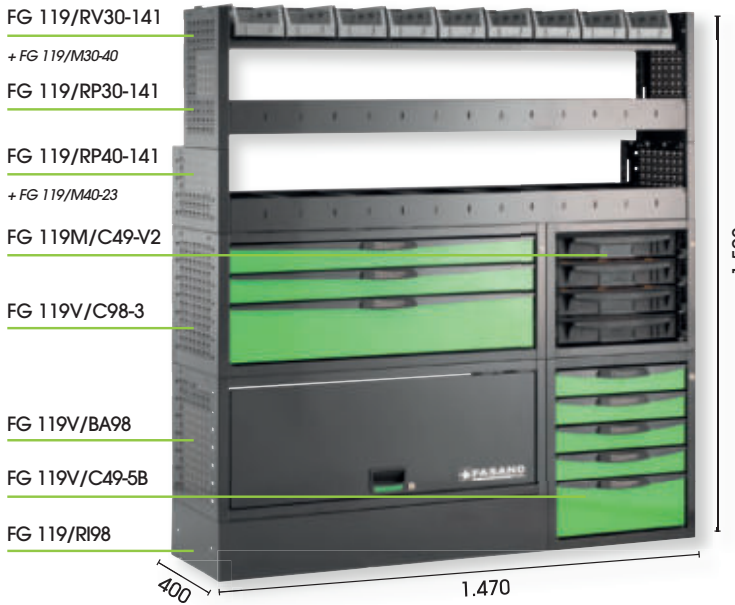

FG 119V/CO32
CONFIGURAZIONE ALLESTIMENTO
TECNICO PER FURGONI

Dimensioni: 1.470x400x1.592mm - Peso: 113,9Kg



FG 119B/CO32



FG 119R/CO32

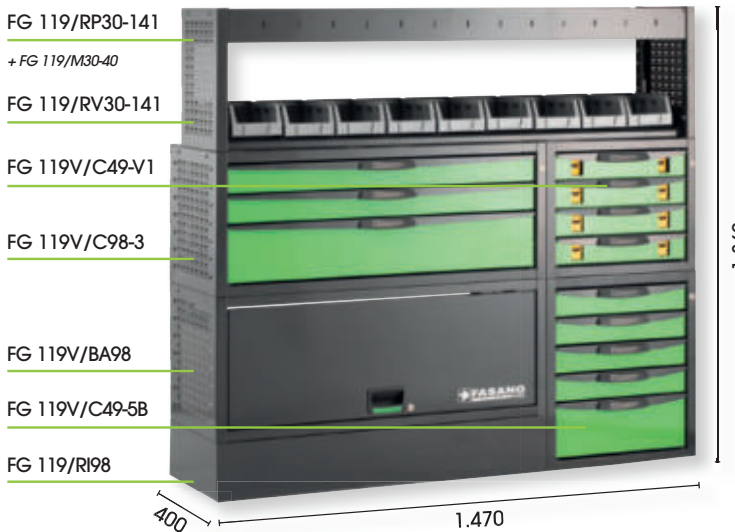

FG 119V/CO33
CONFIGURAZIONE ALLESTIMENTO
TECNICO PER FURGONI

Dimensioni: 1.470x400x1.360mm - Peso: 114Kg



FG 119B/CO33



FG 119R/CO33

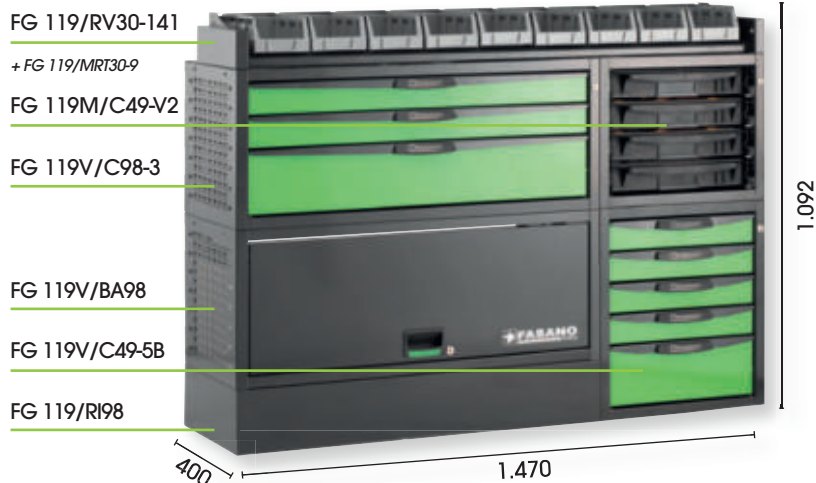

FG 119V/CO34

CONFIGURAZIONE ALLESTIMENTO TECNICO PER FURGONI

Dimensioni: 1.470x400x1.092mm - Peso: 94,1Kg



FG 119B/CO34



FG 119R/CO34

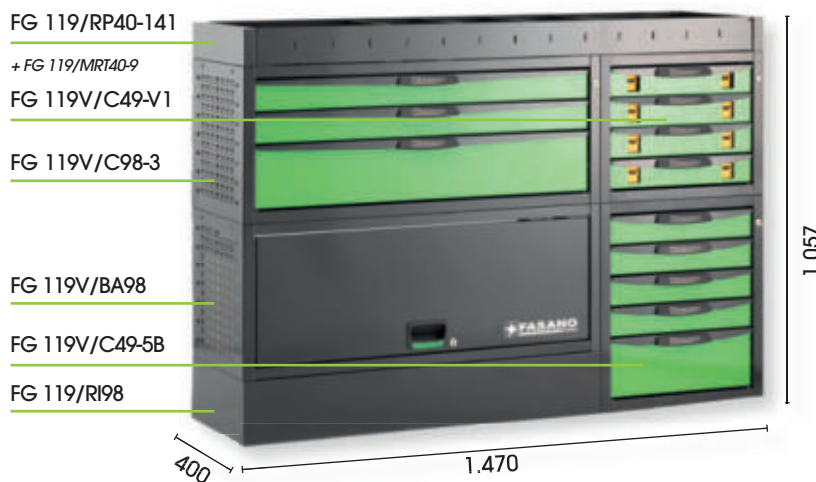

FG 119V/CO35

CONFIGURAZIONE ALLESTIMENTO TECNICO PER FURGONI

Dimensioni: 1.470x400x1.057mm - Peso: 107,3Kg



FG 119B/CO35



FG 119R/CO35

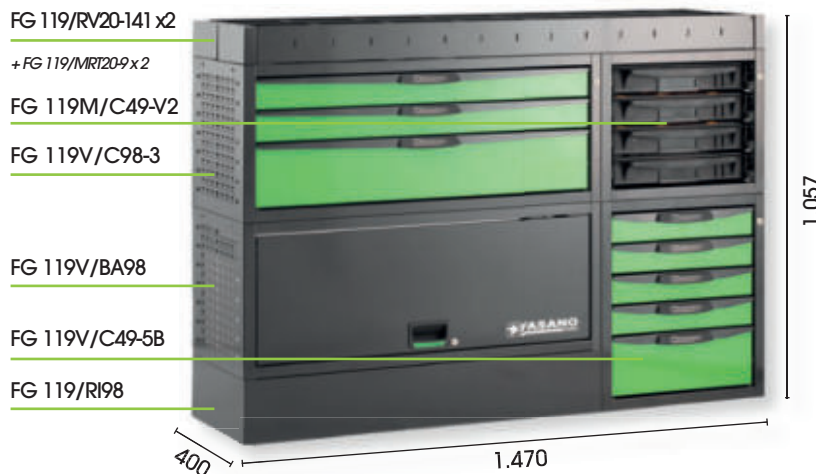

FG 119V/CO36

CONFIGURAZIONE ALLESTIMENTO TECNICO PER FURGONI

Dimensioni: 1.470x400x1.057mm - Peso: 98,9Kg



FG 119B/CO36



FG 119R/CO36



Allestimento furgoni!

Totalmente personalizzabile e modulare, si compone di cassettiere, armadietti, mensole, scaffali e pareti provviste di griglie portautensili, porta minuterie e una vasta gamma di accessori.

Tutto il necessario per lavorare al di fuori della propria officina, seppur portandola sempre con sé.

L'arredo tecnico Fasano Tools dedicato ai veicoli attrezzati si adegua perfettamente ad ogni necessità del lavoro quotidiano. Scegli il colore e la composizione ideale!



MADE IN ITALY



**ARREDO TECNICO
PER VEICOLI ATTREZZATI**

MODULI ARREDAMENTO TECNICO CON BANCO DA LAVORO



PIANO DI LAVORO IN LEGNO

Multistrato pioppo
Dimensioni e peso:

FG 119/49TL 490x18x400mm - 1,6Kg

FG 119/73TL 735x18x400mm - 2,4kg

FG 119/98TL 980x18x400mm - 3,2Kg

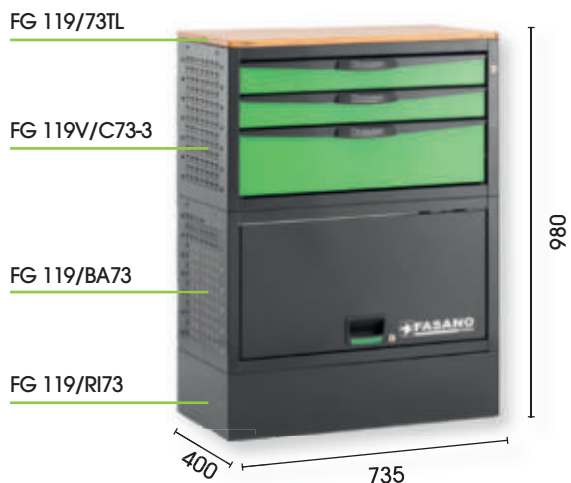

FG 119V/CO7
CONFIGURAZIONE ALLESTIMENTO
TECNICO PER FURGONI
Dimensioni: 735x400x980mm - Peso:38,9Kg



FG 119B/CO7

FG 119R/CO7

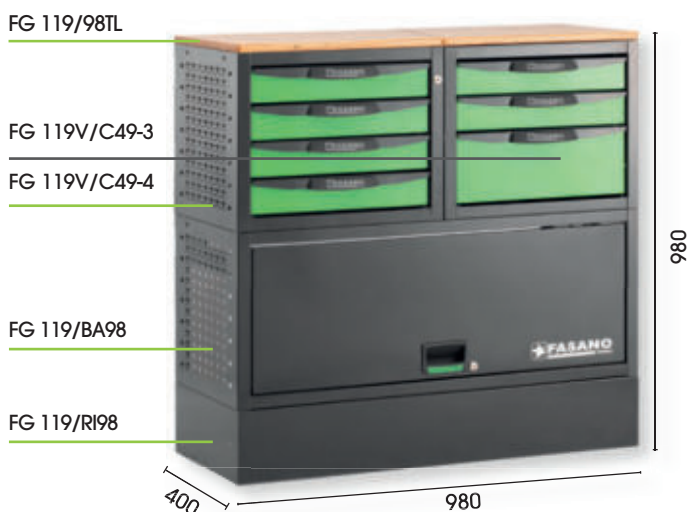

FG 119V/CO18
CONFIGURAZIONE ALLESTIMENTO
TECNICO PER FURGONI
Dimensioni: 980x400x980mm - Peso:56,5Kg



FG 119B/CO18

FG 119R/CO18



FG 119V/CO27
CONFIGURAZIONE ALLESTIMENTO
TECNICO PER FURGONI
Dimensioni: 1.225x400x980mm - Peso:71,6Kg



FG 119B/CO27

FG 119R/CO27

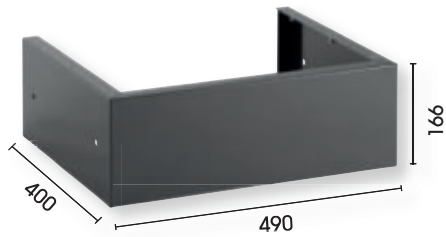

FG 119/RI49

RIALZO PER BASI APERTE O CHIUSE

Dimensioni: 490x400x166mm

Peso: 2,4Kg

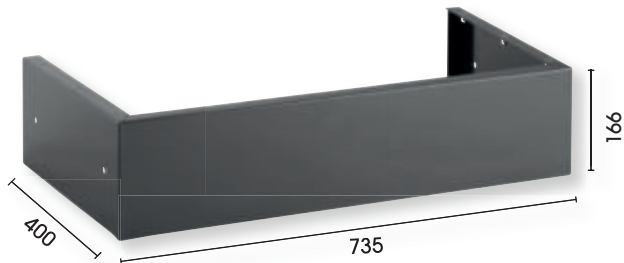

FG 119/RI73

RIALZO PER BASI APERTE O CHIUSE

Dimensioni: 735x400x166mm

Peso: 2,8Kg

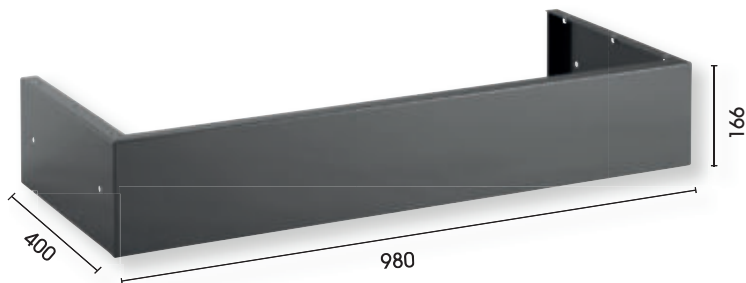

FG 119/RI98

RIALZO PER BASI APERTE O CHIUSE

Dimensioni: 980x400x166mm

Peso: 3,2Kg

BASI APERTE



FG 119V/BA49

BASE APERTA

Da posizionare sul passaruota

Dimensioni: 490x400x398mm

Peso: 7,7Kg



FG 119B/BA49

FG 119R/BA49



FG 119V/BA73

BASE APERTA

Da posizionare sul passaruota

Dimensioni: 735x400x398mm

Peso: 9,6Kg



FG 119B/BA73

FG 119R/BA73



FG 119V/BA98

BASE APERTA

Da posizionare sul passaruota

Dimensioni: 980x400x398mm

Peso: 11,5Kg



FG 119B/BA98



FG 119R/BA98

BASI CHIUSE

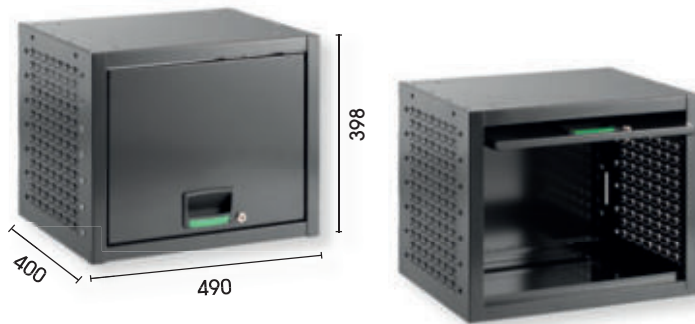

FG 119V/BC49

BASE CHIUSA

Dimensioni: 490x400x398mm

Peso: 10,7Kg



FG 119B/BC49



FG 119R/BC49

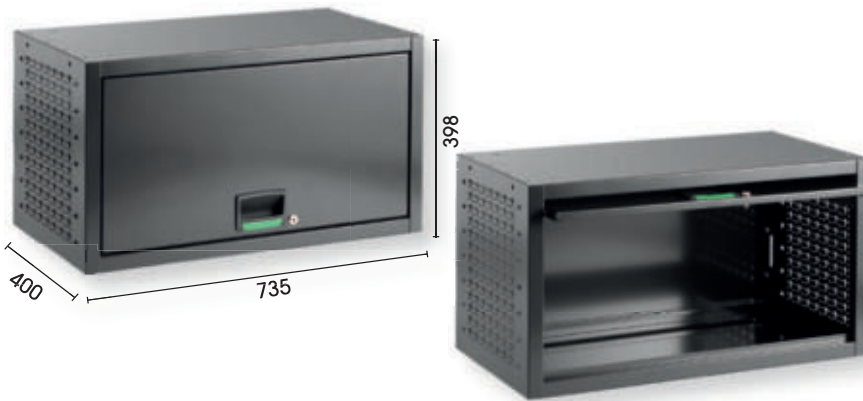

FG 119V/BC73

BASE CHIUSA

Dimensioni: 735x400x398mm

Peso: 14,1Kg



FG 119B/BC73



FG 119R/BC73



FG 119V/BC98

BASE CHIUSA

Dimensioni: 980x400x398mm

Peso: 17,5 Kg



FG 119B/BC98



FG 119R/BC98

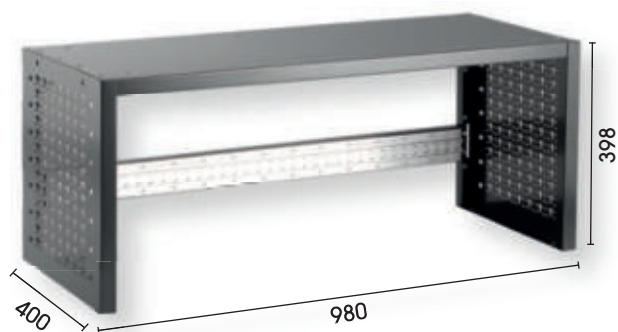

FG 119V/BV98

BASE SENZA RIALZO

Dimensioni: 980x400x398mm

Peso: 8,7Kg

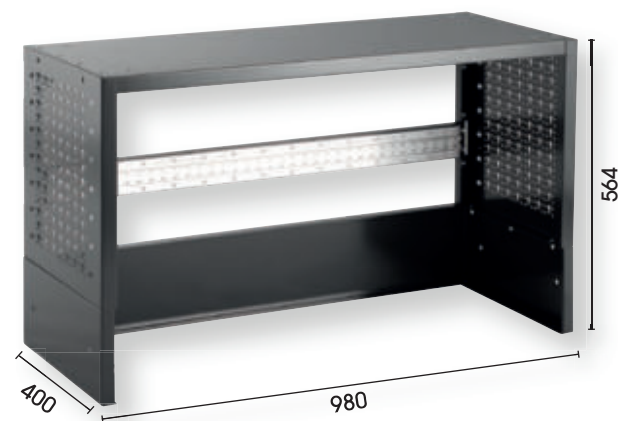
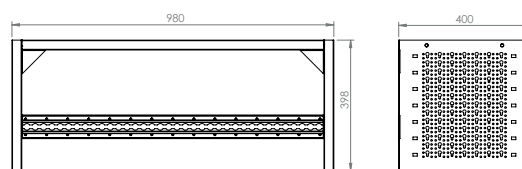

FG 119V/BV98-2

BASE CON RIALZO

Dimensioni: 980x400x564mm

Peso: 11,9Kg

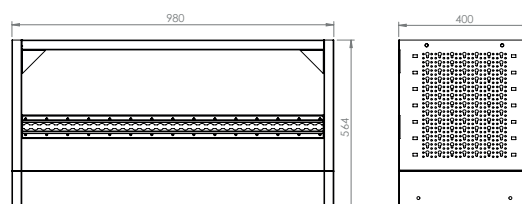

FG 119V/BV98-3

BASE CON RIALZO

Dimensioni: 980x400x564mm

Peso: 10,2Kg

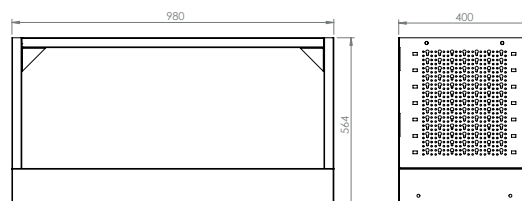

BASI DOTATE DI CASSETTI



FG 119V/C49-3B

BASE CON 3 CASSETTI

Dimensioni: 490x400x564mm - Peso: 22,7Kg

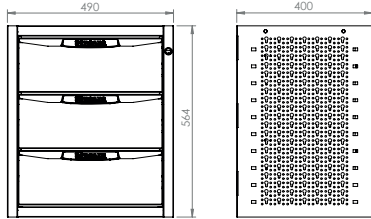

FG 119B/C49-3B



FG 119R/C49-3B



FG 119V/C49-4B

BASE CON 4 CASSETTI

Dimensioni: 490x400x564mm - Peso 24,9Kg

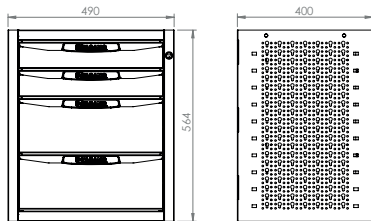

FG 119B/C49-4B



FG 119R/C49-4B



FG 119V/C49-5B

BASE CON 5 CASSETTI

Dimensioni: 490x400x564mm - Peso: 27,1Kg

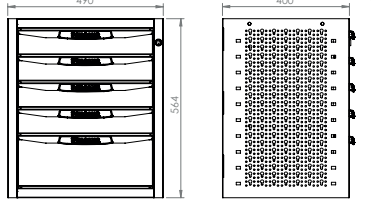

FG 119B/C49-5B



FG 119R/C49-5B



FG 119V/C49-6B

BASE CON 6 CASSETTI

Dimensioni: 490x400x564mm - Peso: 29,3kg

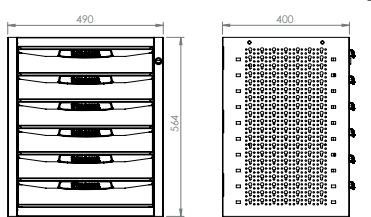

FG 119B/C49-6B



FG 119R/C49-6B



FG 119V/C49-VB

BASE CON 6 CASSETTI

E VALIGETTE PORTA MINUTERIA

Dimensioni: 490x400x564mm - Peso: 36,8Kg

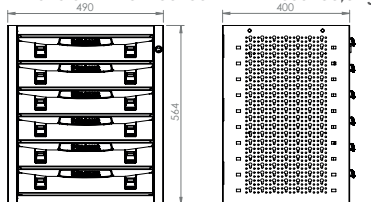

FG 119B/C49-VB



FG 119R/C49-VB

FG 119V/C49-2

CASSETTIERA A 2 CASSETTI

Dimensioni: 490x400x398mm - Peso: 16,6Kg

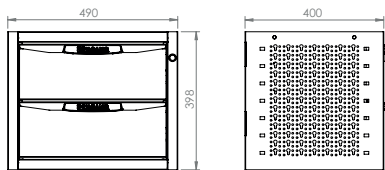
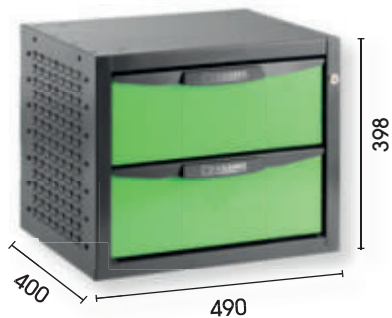

FG 119B/C49-2



FG 119R/C49-2

FG 119V/C49-3

CASSETTIERA A 3 CASSETTI

Dimensioni: 490x400x398mm - Peso: 18,7Kg

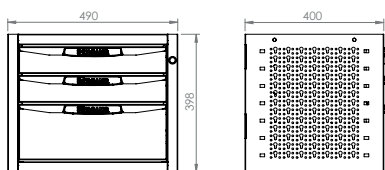

FG 119B/C49-3



FG 119R/C49-3

FG 119V/C49-4

CASSETTIERA A 4 CASSETTI

Dimensioni: 490x400x398mm - Peso: 20,9Kg

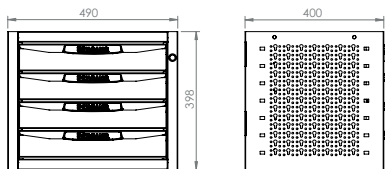

CODICE	PESO	€/Pz
FG 119V/C49-4	20,9 Kg	1.001,00



FG 119B/C49-4



FG 119R/C49-4

FG 119V/C49-V1

CASSETTIERA A 4 CASSETTI

CON VALIGETTE PORTA MINUTERIE

Dimensioni: 490x400x398mm - Peso: 26,0Kg

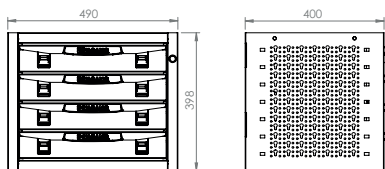

FG 119B/C49-V1



FG 119R/C49-V1



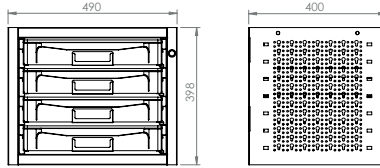
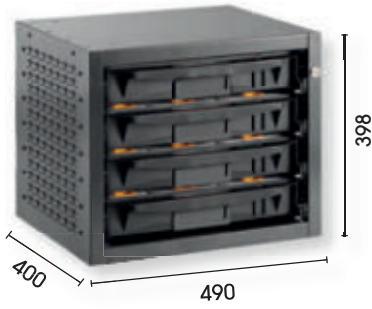

FG 119M/C49-V2
MODULO DOTATO DI 4
VALIGETTE PORTA MINUTERIE

Dimensioni: 490x400x398mmmm - Peso: 15,1Kg



CASSETTO CON APERTURA TOTALE



CHIUSURA LATERALE CENTRALIZZATA



BOX INTERNI PORTA MINUTERIE

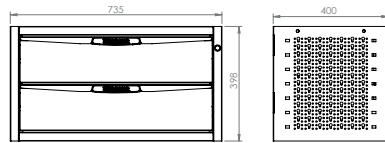

FG 119V/C73-2

CASSETTIERA A 2 CASSETTI

Dimensioni: 735x400x398mmmm - Peso: 21,2Kg



FG 119B/C73-2



FG 119R/C73-2

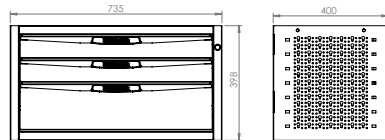

FG 119V/C73-3

CASSETTIERA A 3 CASSETTI

Dimensioni: 735x400x398mmmm - Peso: 24,1Kg



FG 119B/C73-3



FG 119R/C73-3

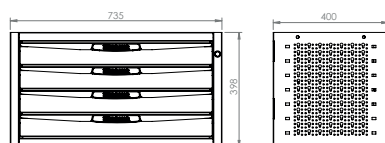

FG 119V/C73-4

CASSETTIERA A 4 CASSETTI

Dimensioni: 735x400x398mmmm - Peso: 27,00Kg



FG 119B/C73-4



FG 119R/C73-4

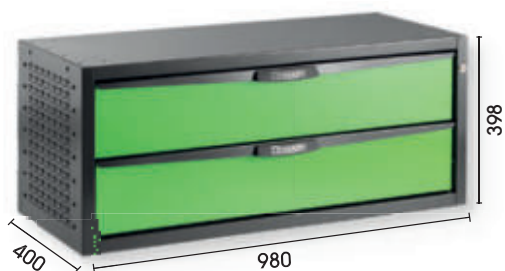

FG 119V/C98-2

CASSETTIERA A 2 CASSETTI

Dimensioni: 980x400x398mm - Peso: 25,8Kg

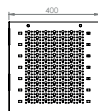
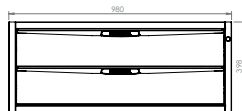

FG 119B/C98-2



FG 119R/C98-2

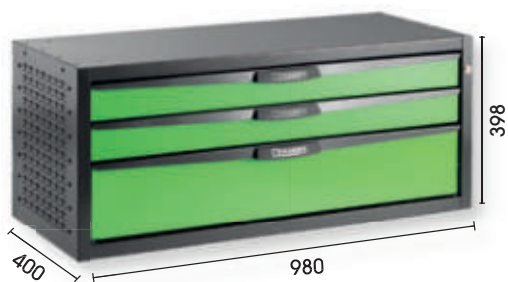

FG 119V/C98-3

CASSETTIERA A 3 CASSETTI

Dimensioni: 980x400x398mm - Peso: 29,5Kg

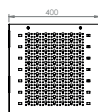
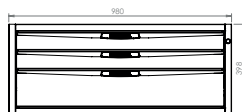

FG 119B/C98-3



FG 119R/C98-3



FG 119V/C98-4

CASSETTIERA A 4 CASSETTI

Dimensioni: 980x400x398mm - Peso: 33,1Kg

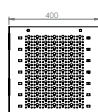
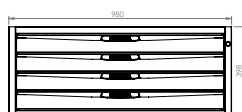

FG 119B/C98-4



FG 119R/C98-4

MODULO CASSETTIERA CON VALIGETTE



FG 119M/C98-V

CASSETTIERA CON 4 VALIGETTE ESTRAIBILI E IMPILABILI

Dimensioni: 980x400x398mm - Peso: 27,0Kg

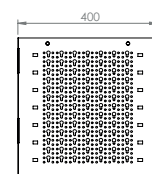
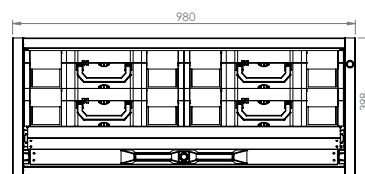

APERTURA TOTALE 4 VALIGETTE IMPILABILI



AGGANCIAMENTO VALIGETTA



VALIGETTE DOTATE DI BOX INTERNI PORTA MINUTERIE

RIPIANI CON DIVISORI AMOVIBILI

FG 119/RP40-67

N. divisori 4 - FG 119/D40 - Peso: 5,1Kg

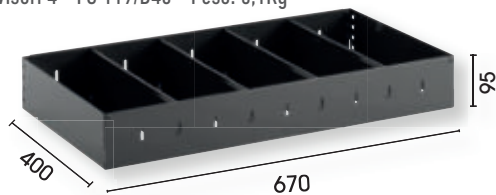

FG 119/RP40-116

N. divisori 5 - FG 119/D40 - Peso: 771Kg



FG 119/RP30-67

N. divisori 4 - FG 119/D30 - Peso: 4,1Kg

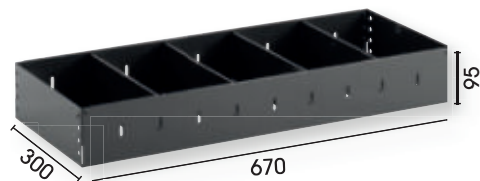

FG 119/RP30-116

N. divisori 5 - FG 119/D30 - Peso: 6,3Kg

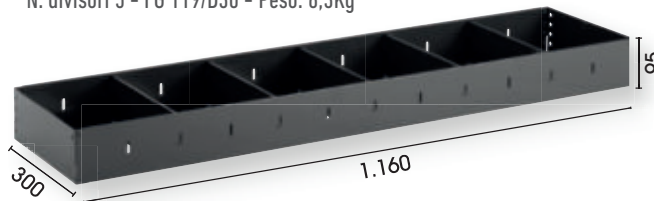

FG 119/RP20-67

N. divisori 4 - FG 119/D20 - Peso: 3,1Kg

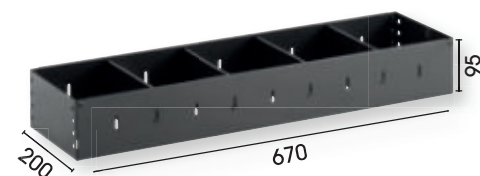

FG 119/RP20-116

N. divisori 5 - FG 119/D20 - Peso: 4,8Kg

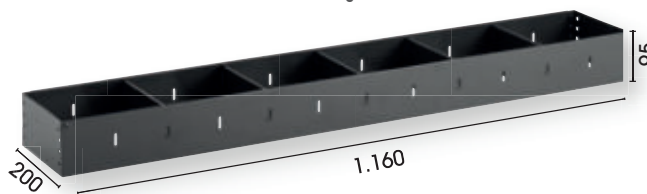

FG 119/RP40-92

N. divisori 5 - FG 119/D40 - Peso: 6,6Kg



FG 119/RP40-141

N. divisori 6 - FG 119/D40 - Peso: 9,2Kg

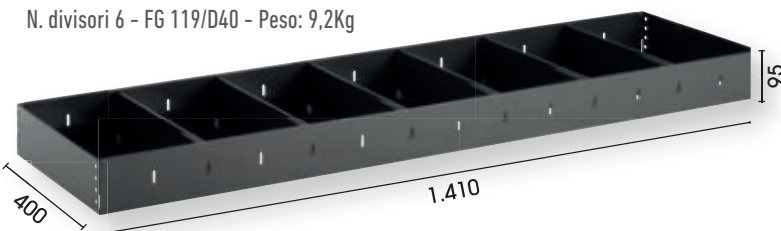

FG 119/RP30-92

N. divisori 5 - FG 119/D30 - Peso: 5,3Kg

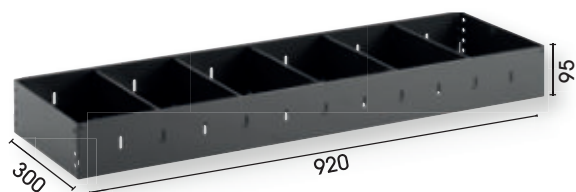

FG 119/RP30-141

N. divisori 6 - FG 119/D30 - Peso: 7,5Kg



FG 119/RP20-92

N. divisori 5 - FG 119/D20 - Peso: 4,1Kg

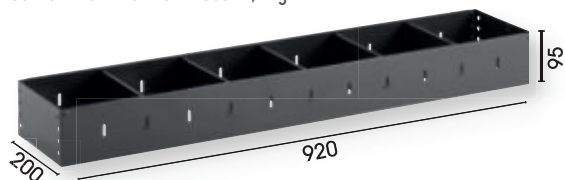

FG 119/RP20-141

N. divisori 6 - FG 119/D20 - Peso: 5,8Kg

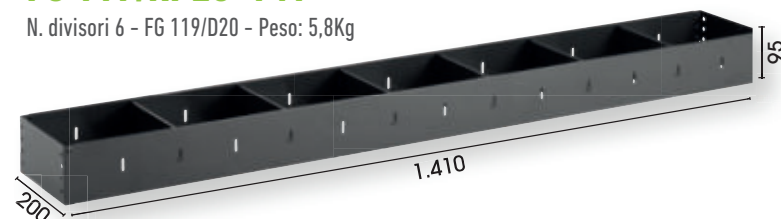

RIPIANI CON VASCHEE IN PLASTICA

FG 119/RV40-67

N. vaschette 3 - FG 119/VA40 - Peso: 5,6Kg

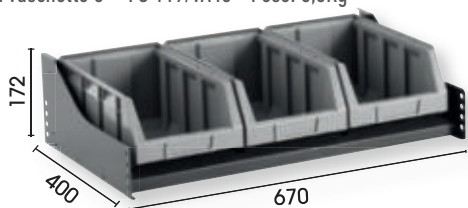

FG 119/RV40-116

N. vaschette 5 - FG 119/VA40 - Peso: 8,9Kg



FG 119/RV30-67

N. vaschette 4 - FG 119/VA30 - Peso: 3,7Kg

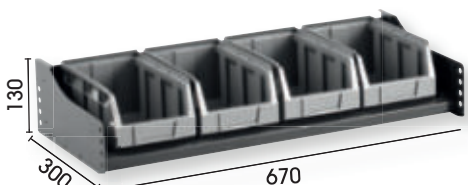

FG 119/RV30-116

N. vaschette 7 - FG 119/VA30 - Peso: 5,9Kg

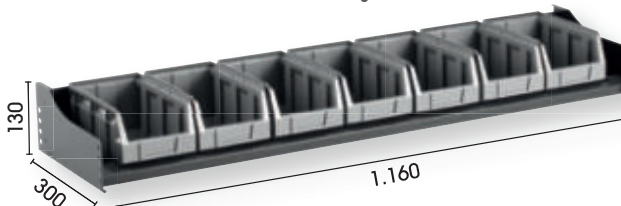

FG 119/RV20-67

N. vaschette 6 - FG 119/VA20 - Peso: 2,5Kg

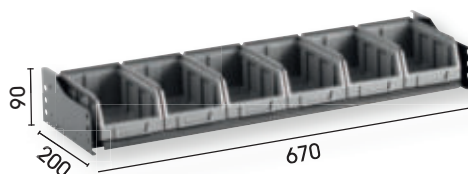

FG 119/RV20-116

N. vaschette 10 - FG 119/VA20 - Peso: 3,9Kg

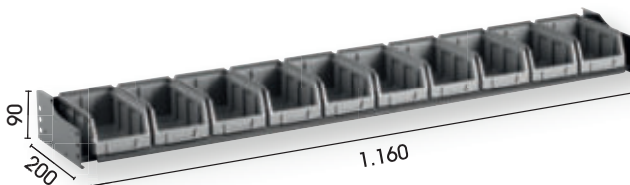

FG 119/RV40-92

N. vaschette 4 - FG 119/VA40 - Peso: 7,3Kg

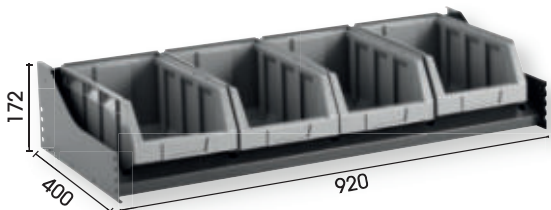

FG 119/RV40-141

N. vaschette 6 - FG 119/VA40 - Peso: 10,6Kg

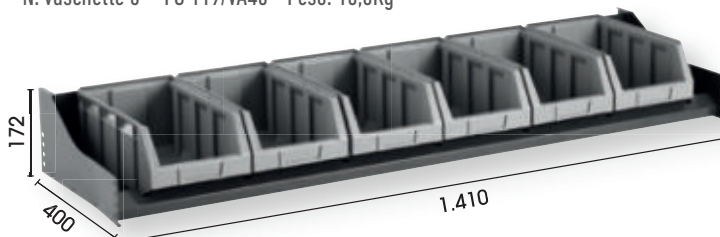

FG 119/RV30-92

N. vaschette 6 - FG 119/VA30 - Peso: 4,9Kg

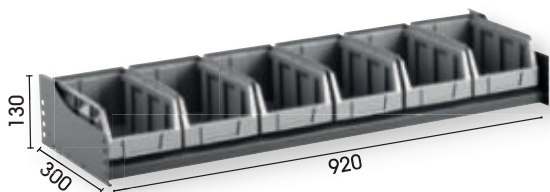

FG 119/RV30-141

N. vaschette 9 - FG 119/VA30 - Peso: 7,1Kg

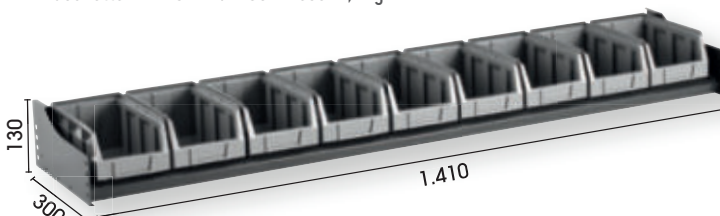

FG 119/RV20-92

N. vaschette 8 - FG 119/VA20 - Peso: 3,2Kg

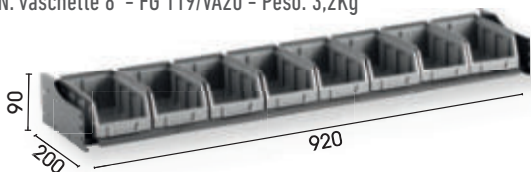

FG 119/RV20-141

N. vaschette 12 - FG 119/VA20 - Peso: 4,7Kg



BOX PORTA MINUTERIE

FG 119/VA20

BOX PORTA MINUTERIA

Dimensioni: 105x167x82
Portata: 3,12Kg
Peso: 0,1Kg

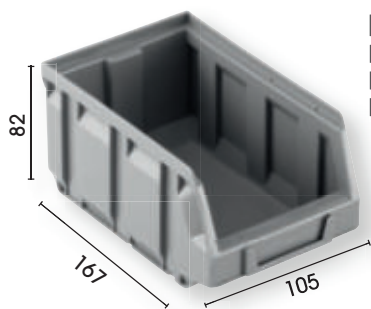

FG 119/VA30

BOX PORTA MINUTERIA

Dimensioni: 144x237x123
Portata: 10,30kg
Peso: 0,2Kg

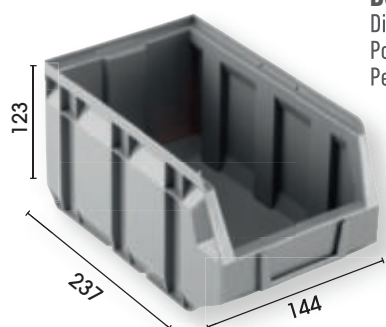

FG 119/VA40

BOX PORTA MINUTERIA

Dimensioni: 205x345x164
Portata: 20,60Kg
Peso: 0,6Kg

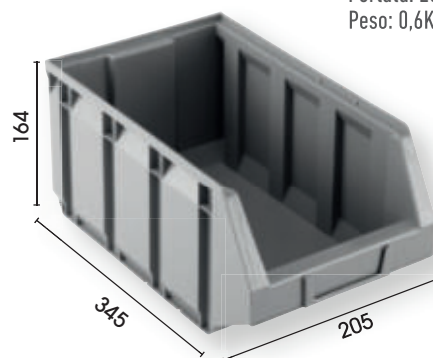

DIVISORI AMOVIBILI

FG 119/D30

DIVISORI PER RIPIANI

Dimensioni: 290x91
Peso: 0,24Kg

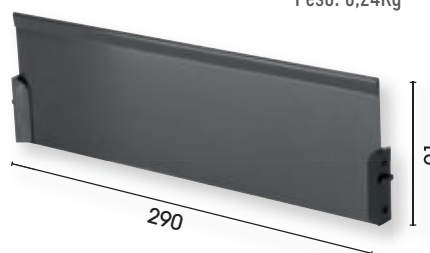

FG 119/D40

DIVISORI PER RIPIANI

Dimensioni: 390x91
Peso: 0,32kg



FG 119/D20

DIVISORI PER RIPIANI

Dimensioni: 190x91
Peso: 0,15Kg

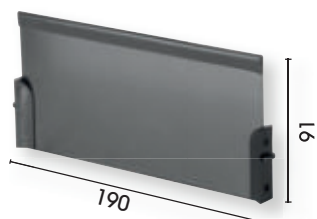

COPPIE DI MONTANTI LATERALI

FG 119/M40-23

Peso: 1,7Kg

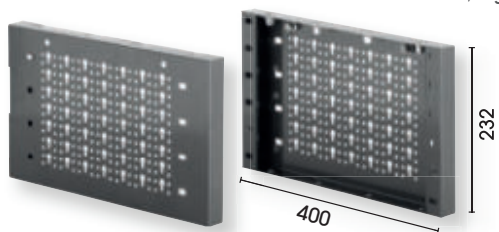

FG 119/M40-40

Peso: 2,7Kg

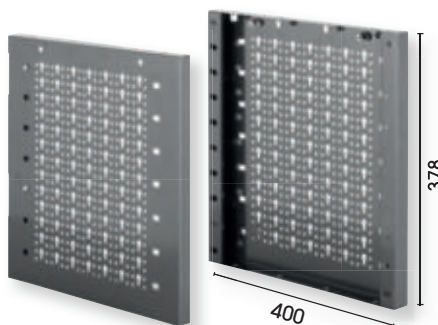

FG 119/M40-56

Peso: 3,6Kg

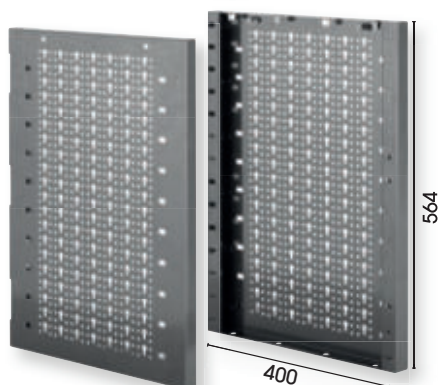

FG 119/M30-23

Peso: 1,4Kg

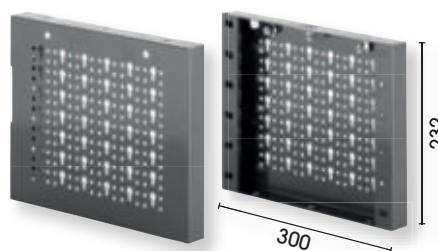

FG 119/M30-40

Peso: 2,2Kg

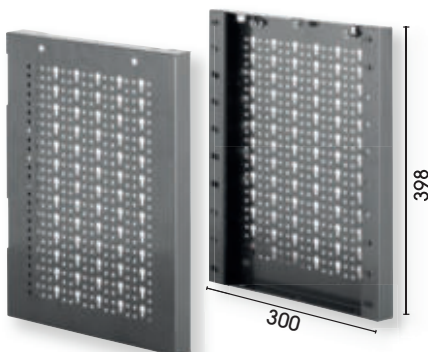

FG 119/M20-23

Peso: 1,0Kg

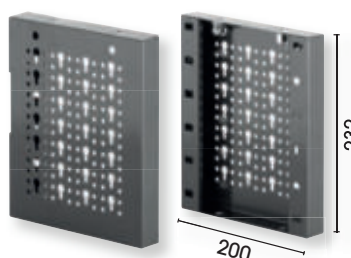

FG 119/M20-40

Peso: 1,7Kg

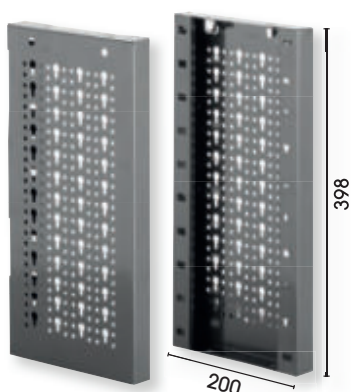

FG 119/MRT20-9

Peso: 0,6Kg

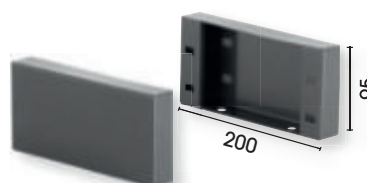

FG 119/MRT30-9

Peso: 0,8Kg



FG 119/MRT40-9

Peso: 1,0Kg

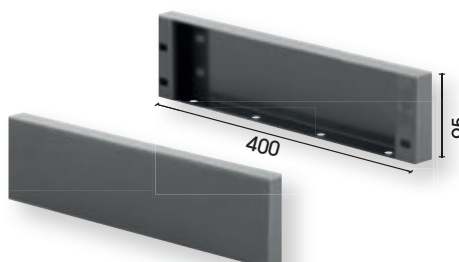

ACCESSORI



FG 119/BL

BANCO DA LAVORO

Dimensioni piani: 810x250mm - Peso: 22,3Kg



PIANO DA LAVORO ESTRAIBILE



LEVA PER APERTURA E CHIUSURA



LEVA DI BLOCCAGGIO



FG 119/PM

**BANCO DA LAVORO DOTATO
DI MORSA 125MM CON
BASE GIREVOLE**

Dimensioni piano: 560x250mm - Peso: 40,5Kg

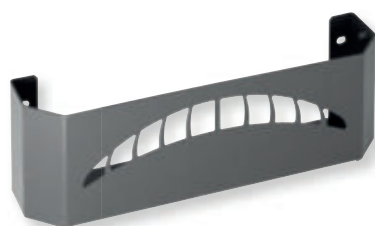

FG 100/PL
PORTA LATTINE



FG 119/PR
PORTA ROTOLO

BINARIO

CODICE	L/MM
FG 119/BIN178	178mm
FG 119/BIN330	330mm
FG 119/BIN483	483mm
FG 119/BIN635	635mm
FG 119/BIN787	787mm
FG 119/BIN940	940mm
FG 119/BIN3000	3000mm



BARRE DOPPIO PIANO

CODICE	L/MM	PORTATA
FG 119/BP1000	800 -1000mm	300 daN
FG 119/BP1300	950 -1300mm	300 daN
FG 119/BP1750	1250 -1750mm	300 daN



ROTAIA

CODICE	L/MM
FG 119/ROT3000	3000mm



CINGHIE

CODICE	L/MM - PORTATA
FG 119/C75-A	0,75m - 1.750 N
FG 119/C150-A	1,5m - 1.750 N
FG 119/C100-B	1m - 4.000 N
FG 119/C200-B	2m - 4.000 N
FG 119/C100-C	1m - 7.500 N
FG 119/C200-C	2m - 7.500 N

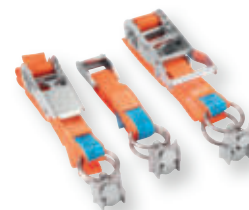

ROTAIA

CODICE	L/MM
FG 119/ROL3000	3000mm

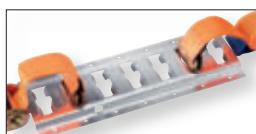

CINGHIE

CODICE	L/MM - PORTATA
FG 119/C400D	4m - 6.750 N



PALI FERMACARICO

CODICE	L/MM	PORTATA
FG 119/PF1760	1160 -1760mm	3.000 N
FG 119/PF2300	1700 - 2300mm	3.000 N



COPPIA DI TERMINALI

CODICE	PORTATA
FG 119/TE1	4000 N
FG 119/TE2	11.250 N



PALI COMBINATI

CODICE	L/MM	PORTATA
FG 119/PC1350	1050 -1350mm	3.500 N
FG 119/PC1600	1300 -1600mm	3.500 N
FG 119/PC1850	1550 -1850mm	3.500 N
FG 119/PC2100	1800 - 2100mm	3.500 N



BICCHIERI COPRIFORO CON GANCIO FERMACARICO



FG 119/IP1



FG 119/IP2

TAPPI TERMINALI PER BINARI FG 119/BN



PIANALI IN LEGNO FENOLICO, 12MM

Il materiale con il quale sono prodotti i pianali è legno di Betulla spessore 12 mm, di colore grigio, rivestito con film fenolico ideale per essere utilizzato dove è richiesta un'alta resistenza all'usura. La superficie ha una speciale impronta antiscivolo, è resistente all'acqua, agli agenti atmosferici e alle sostanze chimiche. Inoltre il prodotto è ecofriendly, igienico e semplice da pulire.

E' studiato per poter essere fornito in kit di montaggio a qualsiasi tipo di utenza e non richiedono attrezzature particolari.

Vengono forniti di serie con

- profili in alluminio per battute portiere posteriori e laterali
- ganci fermacarico e bicchieri copriforo.

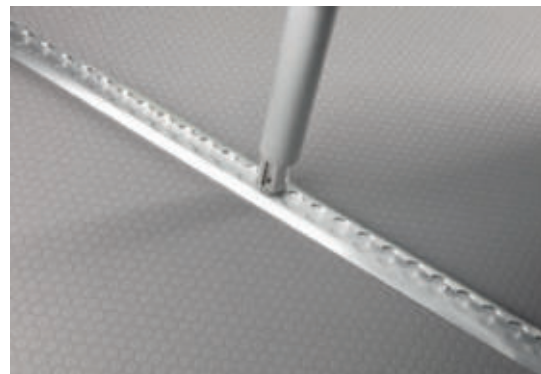
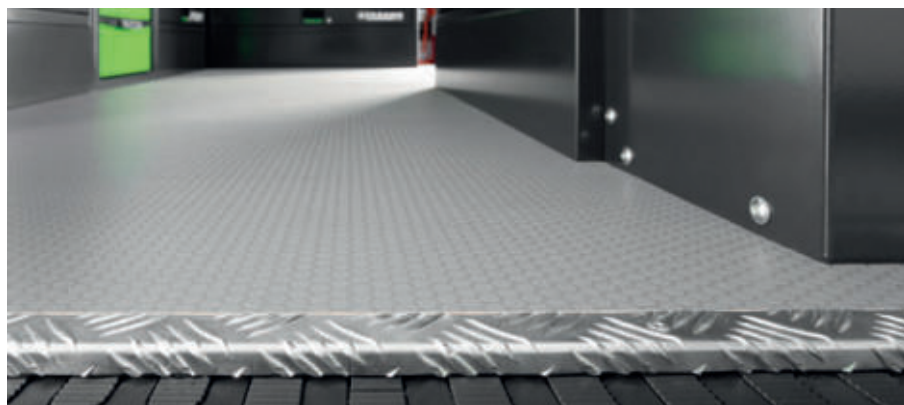

INQUADRA CON LO SMARTPHONE IL QR CODE
E SCEGLI IL **PIANALE**
IN BASE AL MODELLO DEL TUO FURGONE



RIVESTIMENTI IN POLIPROPILENE

PANNELLATURE IN PPL ALVEOLARE

Il rivestimento interno è indicato per evitare danni di carrozzeria causati dall'urto delle merci ed è facilmente installabile.

Il materiale utilizzato è il PPL (Polipropilene) alveolare di colore grigio e spessore 4 mm. I pannelli sono impermeabili, antigraffio e antimuffa. Facili da pulire e resistenti alle alte temperature, ad acqua e olio.



INQUADRA CON LO SMARTPHONE IL QR CODE
E SCEGLI IL **RIVESTIMENTO**
IN BASE AL MODELLO DEL TUO FURGONE





Moduli in Gomma (Eva Foam)

Organizza i tuoi utensili con i nostri moduli in gomma, da assemblare e modulare a tua scelta, in base alle dimensioni del cassetto.

Ordine e funzionalità per il tuo lavoro!

Il Sistema modulare ti permette di personalizzare l'allestimento furgoni a seconda delle tue necessità per rendere più funzionale e veloce il tuo lavoro.

COMPONI IL TUO CASSETTO

Cassetto l/mm 49

1/3
1/3

1/3	
1/6	1/6

2/3

1/2
1/6A

Cassetto l/mm 73

1/3	1/6
1/3	1/6

1/3	1/6	
1/6	1/6	1/6

2/3	1/6
	1/6

1/2	1/6
1/6A	1/6

Cassetto l/mm 98

1/3	1/3
1/3	1/3

2/3	2/3
-----	-----

2/3	1/3
	1/3

1/2	1/6	1/6
1/6A	1/6	1/6

FG 100/03G

MODULO 14 CHIAVI COMBinate IN MM

FG 600/B6,7,8,9,10,11,12,13, 14,15,16,17,18,19mm



1/3

FG 100/03H

MODULO 18 CHIAVI COMBinate IN MM

FG 600/B6,7,8,10,11,12,13,14,16,17,18,19, 21, 22, 24, 27, 30, 32mm

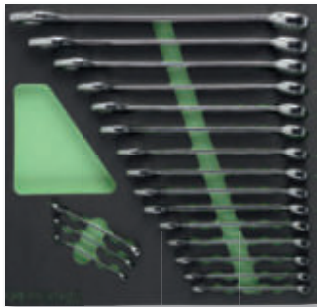

2/3

FG 100/03TX

MODULO 4 CHIAVI DOPPIE POLIGONALI

FG 600/E6xE8, E10xE12, E14xE18, E20xE24



1/6

FG 100/07D

MODULO 5 CHIAVI DOPPIE POLIGONALI

FG 615/B20x22, 21x23, 24x27, 25x28, 30x32mm



1/3

FG 100/13C

MODULO 10 CHIAVI A PIPA 6X12PT

FG 613/A6,7,8,10,11,12,13,14,17,19mm



1/3

FG 100/03F

MODULO 5 CHIAVI DOPPIA FORCHETTA

FG 602/B21x23, 24x26, 25x28, 27x29, 30x32 mm



1/3

FG 100/03L

MODULO 6 CHIAVI COMBinate IN MM

FG 600/B21,22,24,27,30,32mm



1/3

FG 100/03E

MODULO 8 CHIAVI DOPPIA FORCHETTA

FG 602/B6x7, 8x9, 10x11, 12x13, 14x15, 16x17, 18x19, 20x22 mm + FG 139C/FS



1/3

FG 100/07C

MODULO 7 CHIAVI DOPPIE POLIGONALI

FG 615/B6x7, 8x9, 10x11,12x13, 14x15, 16x17, 18x19mm

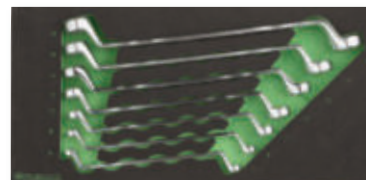

1/3

FG 100/12B

MODULO 8 CHIAVI A TUBO MOD. PESANTE

FG 614/A6x7,8x9,10x11,12x13,14x15,16x17,18x19,20x22



1/3

FG 100/08C

MODULO 8 CHIAVI A CRICCHETTO

FG 605/B8, 10, 11, 12, 13, 14, 15, 16, 17, 18, 19mm



1/3

FG 100/03IN

MODULO 9 CHIAVI COMBinate IN POLLICI

FG 600/IN1/4", 5/16", 3/8", 7/16", 1/2", 9/16", 5/8", 11/16", 3/4"



1/3

FG 100/17E

MODULO CHIAVI A BUSSOLA ESAGONALI

1/4"



1/3

4,5,6,7,8,9,10,
11,12,13,14mm

FG 624/CR14

FG 624/PA50, 100

FG 624/PRF150

FG 624/ES14

FG 624/SN14

FG 624/GR14C

FG 147/H1.5H10

FG 147/PH1-PH4

FG 147/TX8-TX40

FG 147/SL1-SL5

FG 139/L

FG 100/17

MODULO CHIAVI A BUSSOLA ESAGONALI

1/4"



1/3

FG 624/E4,5,6,7,8,9,10,
11,12,13,14mm

FG 624/CR14

FG 624/SN14

FG 624/GR14C

FG 624/PA50, 100

FG 624/PRF150

FG 624/ES14

FG 100/17IN

MODULO CHIAVI A BUSSOLA ESAGONALI

1/4"



1/3

5/32, 3/16, 7/32, 1/4, 9/32, 5/16,
11/32, 3/8, 7/16, 15/32, 1/2, 9/16

FG 624/CR14

FG 624/SN14

FG 624/GR14C

FG 624/PA50, 100

FG 624/PRF150

FG 624/ES14

FG 100/18

MODULO CHIAVI A BUSSOLA ESAGONALI

3/8"



1/3

FG 624/B8, 9, 10, 11, 12, 13,
14, 15, 16, 17, 18, 19, 21 mm

FG 624/CR38

FG 624B/PA75, 100, 125, 250

FG 624/SN38

FG 624/ES38

FG 100/19

MODULO CHIAVI A BUSSOLA ESAGONALI

3/8"



1/3

FG 624B/L8,9,10,11,12,13,14,
15, 16, 17, 18, 19, 21, 22, 23mm

FG 624/CR38

FG 624B/PA75, 100, 125, 250

FG 624/SN38

FG 624/ES38

FG 100/19IN

MODULO CHIAVI A BUSSOLA ESAGONALI

3/8"

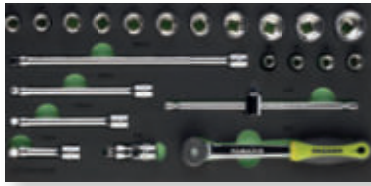

1/3

1/4", 5/16", 11/32", 3/8", 7/16", 15/32",
1/2", 9/16", 19/32", 5/8", 11/16", 3/4",
25/32", 13/16", 7/8", 15/16"

FG 624/SN38

FG 624/CR38

FG 624/ES38

FG 624B/PA75, 100, 125, 250

FG 100/18B

MODULO CHIAVI A BUSSOLA POLIGONALI

3/8"



1/3

FG 624/L8, 9, 10, 11, 12, 13,
14, 15, 16, 17, 18, 19 mm

FG 624/SN38

FG 624/CR38

FG 624/ES38

FG 624B/PA75, 100, 125, 250

FG 100/19B

MODULO CHIAVI A BUSSOLA POLIGONALI

3/8"



1/3

FG 624/L8, 9, 10, 11, 12, 13, 14,
15, 16, 17, 18, 19, 21 mm

FG 624/SN38

FG 624/CR38

FG 624/ES38

FG 624B/PA75, 100, 125, 250

FG 100/21B

MODULO CHIAVI A BUSSOLA POLIGONALI

1/2"



1/3

FG 625/A10, 11, 12, 13, 14, 15,
16, 17, 18, 19, 20, 21, 22, 23, 24,
25, 26, 27, 30, 32 mm

FG 625/SN12

FG 625/CR12

FG 625/ES12

FG 625/PA125, 250

FG 100/21C

MODULO CHIAVI A BUSSOLA POLIGONALI

1/2"



1/3

FG 625/C10, 11, 12, 13, 14, 15,
16, 17, 18, 19, 20, 21, 22, 23, 24,
25, 26, 27, 30, 32 mm

FG 625/SN12

FG 625/CR12

FG 625/ES12

FG 625/PA125, 250

FG 100/21D

MODULO CHIAVI A BUSSOLA POLIGONALI

1/2"



1/3

FG 625/C8, 10, 12, 13, 15,
17, 19, 21, 24, 27, 30, 32 mm

FG 625/SN12

FG 625/CR12

FG 625/ES12

FG 625/PA125

FG 100/21M

MODULO CHIAVI A BUSSOLA ESAGONALI

1/2"

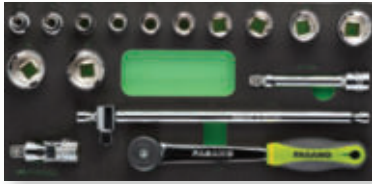

1/3

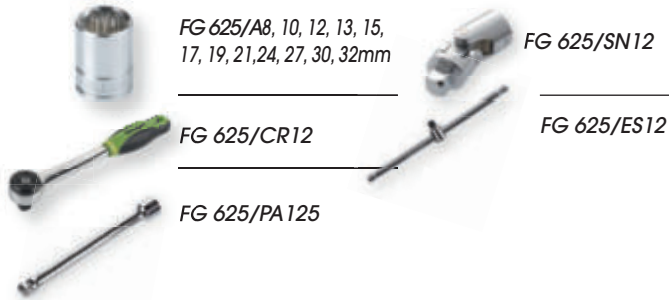

FG 625/A8, 10, 12, 13, 15,
17, 19, 21, 24, 27, 30, 32mm

FG 625/SN12

FG 625/CR12

FG 625/ES12

FG 625/PA125

FG 100/21IN

MODULO CHIAVI A BUSSOLA ESAGONALI

1/2"



1/3

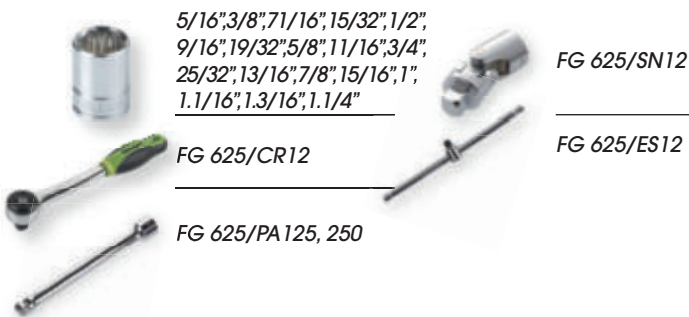

5/16", 3/8", 7/16", 15/32", 1/2",
9/16", 19/32", 5/8", 11/16", 3/4",
25/32", 13/16", 7/8", 15/16", 1",
1.1/16", 1.3/16", 1.1/4"

FG 625/SN12

FG 625/CR12

FG 625/ES12

FG 625/PA125, 250

FG 100/21TX

MODULO UTENSILI CON IMPRONTA TORX

1/4" 1/2"



1/3

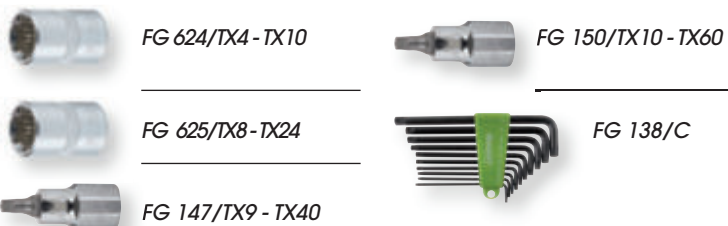

FG 624/TX4 - TX10

FG 150/TX10 - TX60

FG 625/TX8 - TX24

FG 138/C

FG 147/TX9 - TX40

FG 100/21E

MODULO CHIAVI A BUSSOLA ESAGONALI

1/4" 1/2"



1/2

FG 100/21G

MODULO CHIAVI A BUSSOLA ESAGONALI

1/4" 1/2"



1/3

FG 100/21H

MODULO CHIAVI A BUSSOLA ESAGONALI

1/2"

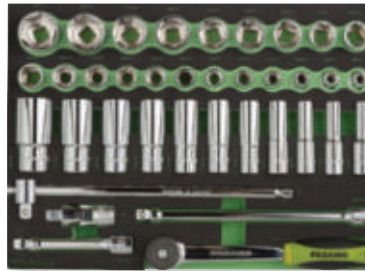

1/2

FG 100/23B

MODULO 19 CHIAVI A BUSSOLA RINFORZATE

1/2"

FG 628/L10, 11, 12, 13, 14, 15, 16, 17, 18, 19, 21, 22, 23, 24, 25, 27, 29, 30, 32 mm



1/3

FG 100/23C

MODULO 20 CHIAVI A BUSSOLA RINFORZATE

1/2"

FG 628/C10, 11, 12, 13, 14, 15, 16, 17, 18, 19, 20, 21, 22, 23, 24, 25, 26, 27, 30, 32mm



1/3

FG 100/25

MODULO CHIAVI A BUSSOLA ESAGONALI

3/4"



2/3

34,36,41,46,50mm

FG 629/ES34

FG 629/CR34

FG 629/PR200

FG 625/SN12

FG 100/25B

MODULO CHIAVI A BUSSOLA ESAGONALI

3/4"



2/3

34,36,41,46,50mm

FG 629/ES34

FG 629/CR34

FG 629/PR200

FG 625/SN12

FG 100/39C

MODULO 3 PINZE

FG 59SR/180, FG 61SR/160, FG 63SR/160



1/3

FG 100/42C

MODULO 4 PINZE PER ANELLI ELASTICI

FG 51/180, FG 52/180, FG 53/180, FG 54/180

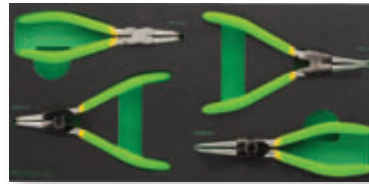

1/3

FG 100/41C

MODULO 4 PINZE PER ANELLI ELASTICI

FG 51/140, FG 52/140, FG 53/140, FG 54/140

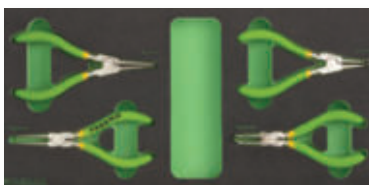

1/3

FG 100/48D

MODULO 40 INSERTI CON ATTACCO 1/4"

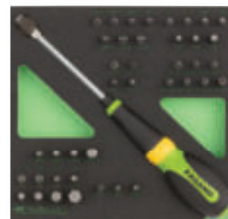

1/6

FG 100/48G

MODULO 52 INSERTI - ATTACCO 10MM

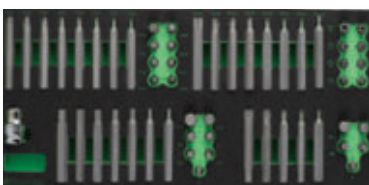

1/3

FG 100/45E

MODULO 8 GIRAVITI TAGLIO E CROCE

3x100, 4x125, 5.5x150, 6.5x150, 6.5x38, PH1x80, PH2x150, PH2x38



1/3

FG 100/45D

MODULO 6 GIRAVITI TAGLIO E CROCE

FG 22/3x100, 4x125, 5.5x150, 6.5x150, FG 22/PH1x80, PH2x150



1/3

FG 100/45G

MODULO 7 GIRAVITI A TAGLIO

2.5x60, 3x100, 3.5x100, 4x125, 5.5x150, 5.5x100, 6.5x150



1/3

FG 100/45H

MODULO 5 GIRAVITI EXTRA LUNGI

FG 22/2.5x300, 4x400, 5.5x400, FG 22/PH1x400, PH2x400

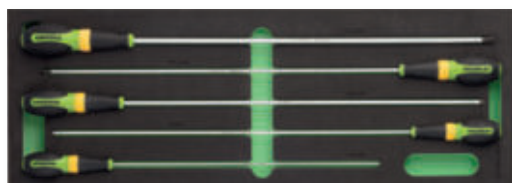

1/2

FG 100/45M

MODULO 6 GIRAVITI A TESTA ESAGONALE

FG 22/H2.5, 3, 4, 5, 6, 8 mm



1/3

FG 100/50E

MODULO CHIAVI MASCHIO ESAGONALI



FG 142/2-10
FG 138



2/3

FG 100/45F

MODULO 6 GIRAVITI A CROCE PHILLIPS

PH0x60, PH1x150, PH2x100, PH2x150, PH3x150, PH2x38



1/3

FG 100/45I

MODULO 6 GIRAVITI CON IMPRONTA TORX

TX10, TX15, TX20, TX25, TX27, TX30



1/3

FG 100/45L

MODULO 6 GIRAVITI CON IMPRONTA TORX FORATA

TX10, TX15, TX20, TX25, TX27, TX30



1/3

FG 100/45T

MODULO 6 GIRAVITI A BUSSOLA ESAGONALE

FG 22/FX6,FX7,FX8,FX10,FX13

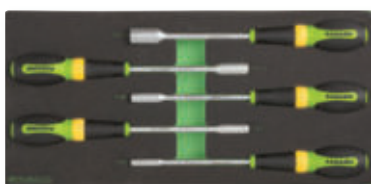

1/3

FG 100/50G

MODULO 6 CHIAVI MASCHIO TORX

FG 143/TX10, TX15, TX20, TX25, TX27, TX30

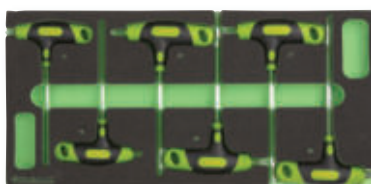

1/3

FG 100/50F

MODULO 6 CHIAVI MASCHIO ESAGONALI

FG 142/2, 2.5, 3, 4, 5, 6

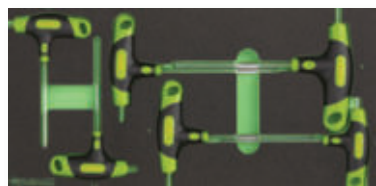

1/3

FG 100/54

MODULO 5 UTENSILI DI MISURAZIONE

FG 95/CA, FG 188/2, FG 95/M1, FG 81/PT1, FG 44/MT5



1/3

FG 100/62B

MODULO LIME A TAGLIO MEZZODOLCE

FG 80/8AR, FG 80/8AM, FG 80/8AP, FG 80/8AT, FG 80/8AQ



1/3

FG 100/68

MODULO 5 LEVAPIOLI

FG 186/S5



1/3

FG 100/81F

MODULO INSERTI A BUSSOLA

FG 150/H2-H8, FG 150L/H2-H8
FG 150/M5-M16, FG 150L/M5-M14



1/3

FG 100/51H

MODULO 7 CHIAVI MASCHIO ESAGONALI

FG 621/H2, 2.5, 3, 4, 5, 6, 8mm



1/3

FG 100/56C

MODULO UTENSILI DA PERCUSSIONE

FG 132/500, FG 136/30, FG 126/SN1, FG 126/SN3



1/3

FG 100/62C

MODULO LIME A TAGLIO BASTARDO

FG 81/8AR, FG 81/8AM, FG 81/8AP, FG 81/8AT, FG 81/8AQ



1/3

FG 100/65B

MODULO PINZE AUTOBLOCCANTI

FG 58/B240 - FG 69/CJ250



1/3

FG 100/82B

MODULO INSERTI A BUSSOLA RIBE

FG 150/R4-R14, FG 150L/R4-R14
FG 150/R4-R14, FG 150L/R4-R14



1/3

FG 100/VA1

MODULO VUOTO PORTA MINUTERIE



1/3

FG 100/VA3

MODULO VUOTO PORTA MINUTERIE



1/3

FG 100/VA2

MODULO VUOTO PORTA MINUTERIE



1/6

FG 100/VA4

MODULO VUOTO PORTA MINUTERIE



1/6A



IL MONDO FASANOTOOLS E' IN CONTINUA EVOLUZIONE

Siamo sempre alla ricerca di nuovi prodotti, sempre più performanti e innovativi, per facilitare il lavoro quotidiano dei professionisti di settore.

RIMANI AGGIORNATO

SEGUICI SUI CANALI SOCIAL



ISCRIVITI ALLA NEWSLETTER

WWW.FASANOTOOLS.COM



FASANOTOOLS.COM

